











Article

Introducing Quantum Technologies at Secondary School Level: Challenges and Potential Impact of an Online Extracurricular Course

Maria Bondani ^{1,*}, Maria Luisa Chiofalo ², Elisa Ercolessi ³, Chiara Macchiavello ⁴,
Marisa Michelini ⁵, Oxana Mishina ⁶, Pasquale Onorato ⁷, Filippo Pallotta ⁸, Sara Satanassi ³,
Alberto Stefanel ⁵, Claudio Sutrinì ⁴, Italo Testa ⁹ and Giacomo Zuccarini ⁴

- ¹ Istituto di Fotonica e Nanotecnologie-CNR-IFN, 22100 Como, Italy
² Dipartimento di Fisica, Università di Pisa, 56122 Pisa, Italy
³ Dipartimento di Fisica e Astronomia “Augusto Righi”, Alma Mater Studiorum Università di Bologna, 40126 Bologna, Italy
⁴ Dipartimento di Fisica, Università di Pavia, 27100 Pavia, Italy
⁵ Unità di Ricerca in Didattica della Fisica, Università di Udine, 33100 Udine, Italy
⁶ Istituto Nazionale di Ottica-CNR-INO, c/o SISSA–Scuola Internazionale Superiore di Studi Avanzati, 34136 Trieste, Italy
⁷ Dipartimento di Fisica, Università di Trento, 38123 Trento, Italy
⁸ Dipartimento di Scienza e Alta Tecnologia-Università dell’Insubria, 20100 Como, Italy
⁹ Dipartimento di Fisica “E. Pancini”, Università Federico II, 80126 Napoli, Italy
* Correspondence: maria.bondani@uninsubria.it



Citation: Bondani, M.; Chiofalo, M.L.; Ercolessi, E.; Macchiavello, C.; Malgieri, M.; Michelini, M.; Mishina, O.; Onorato, P.; Pallotta, F.; Satanassi, S.; et al. Introducing Quantum Technologies at Secondary School Level: Challenges and Potential Impact of an Online Extracurricular Course. *Physics* **2022**, *4*, 1150–1167. <https://doi.org/10.3390/physics4040075>

Received: 2 August 2022

Accepted: 7 September 2022

Published: 29 September 2022

Publisher’s Note: MDPI stays neutral with regard to jurisdictional claims in published maps and institutional affiliations.



Copyright: © 2022 by the authors. Licensee MDPI, Basel, Switzerland. This article is an open access article distributed under the terms and conditions of the Creative Commons Attribution (CC BY) license (<https://creativecommons.org/licenses/by/4.0/>).

Abstract: Stimulated by the European project “QTEdu CSA”, within the flagship “Quantum Technologies”, a community of researchers active in the fields of quantum technologies and physics education has designed and implemented an extracurricular course on quantum physics concepts and quantum technologies applications for high school. The course, which featured eight interactive lectures, was organized online between March and May 2021 and attended by about 250 students from all over Italy. In this paper, we describe the main tenets and activities of the course. Moreover, we report on the effectiveness of the course on students’ knowledge of the basic concepts of quantum physics and students’ views about epistemic aspects and applications of quantum technologies. Results show that the designed activities were effective in improving students’ knowledge about fundamental aspects of quantum mechanics and familiarizing them with quantum technology applications.

Keywords: quantum physics; structural equation modeling; secondary school students

1. Introduction

Industrial policies in the EU and US in the past six years have fostered a fast and increasing interest in quantum mechanics as a pivotal area for the development of future technological and societal advancements [1]. In particular, quantum mechanics is at the heart of innovations that include intelligent sensors, networking, communication, computing hardware, algorithms, and other facilitating technologies. Such interest has led to the launch of far-reaching institutional programs such as the *National Quantum Initiative Act* [2,3] in the US and the *Quantum Flagship* in the EU [4]. However, this interest vividly clashes with physics education research evidence according to which quantum mechanics is perceived as a difficult and demanding subject area, whose concepts are considered too abstract and difficult [5–10]. Many studies also show that students hold a variety of misconceptions in quantum mechanics [11–13] due, for instance, about the need to reconsider the key concepts of classical physics and to bridge physics and chemistry concepts [14–16]. In this study, we propose to use quantum technologies as a suitable educational context to introduce foundational aspects of quantum mechanics at the secondary school level. Our proposal also builds on recent calls by stakeholders in the EU and US to meet future

demand for a well-trained and aptly prepared workforce to be employed in this promising industry field [1].

Stimulated by the European project “QTEdu CSA”, active within the *Quantum Flagship* program we have designed and implemented an educational path for high school extracurricular activities on “Quantum Technologies” aimed at introducing basic concepts of quantum physics in an effective way taking advantage of the context of the second quantum revolution [17].

The activity is the result of the joint efforts of the Italian communities of researchers active in the fields of quantum technologies and physics education.

1.1. The Use of Quantum Technologies to Introduce Quantum Mechanics

We decided to use the context of quantum technologies to convey the concepts of quantum mechanics. Our basic assumption is that quantum technologies may reduce the students’ perceived abstractness of quantum mechanics, which often comes from limited access to suitable experimental and mathematical literacies.

The basic idea of the educational path is to describe the logic of quantum physics by establishing a parallelism with the logic circuits of information theory [18–20]. The axioms of quantum mechanics describe the preparation of a state, its evolution/manipulation, and its measurement, which can be interpreted as information input, information processing, and information output, respectively. This parallelism makes it possible to introduce the fundamental properties of quantum states (superposition and entanglement) and to introduce the “qubit,” the quantum extension of the classical “bit,” and the elementary transformation of the qubit in terms of quantum gates. Simulations and descriptions of experiments with spin and polarization are used to discuss the physical implementation of qubits. The radical novelty introduced by quantum theory becomes clear from the analysis of the superposition state, the meaning of probability, and the role of measurement.

1.2. The Educational Path to Quantum Technologies

The activities of our learning path were structured in the following steps: four introductory lectures (one hour each), an in-depth course of three lectures (one and a half hours each) on specific aspects of quantum technologies, and a closing lecture (one and a half hour); see Figure 1.

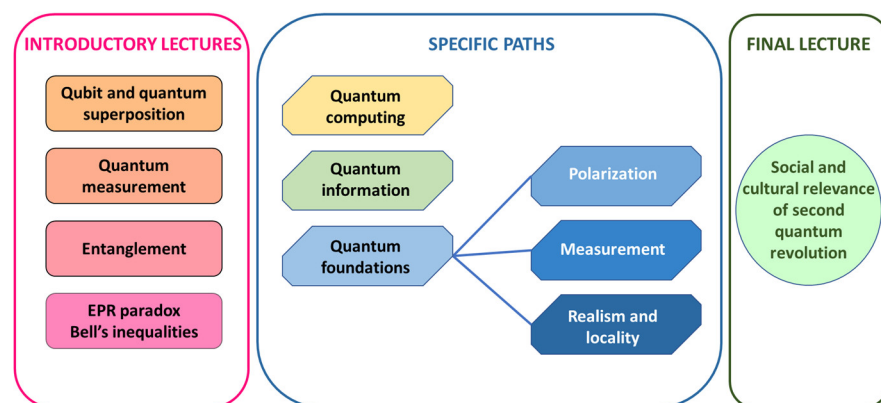

Figure 1. Overview of the educational path activities.

Going into more detail, in the first lecture, starting with the example of the classical and quantum coin flip, we introduce the concepts of quantum superposition state (qubit) and the possible transformations on a single qubit described as logic gates (Figure 2).

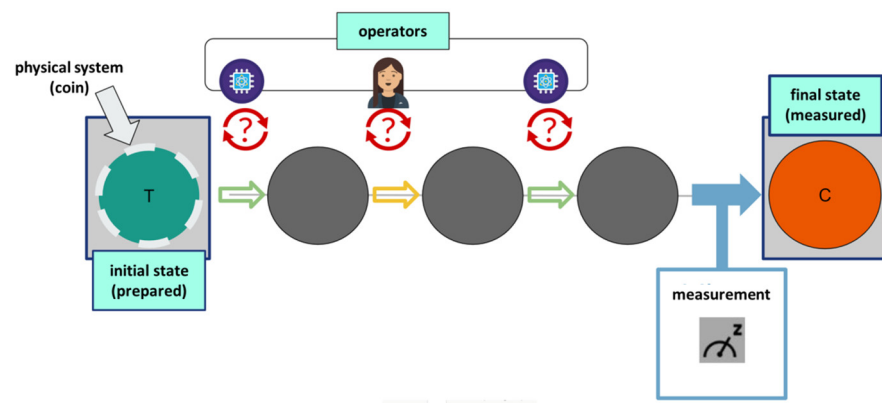

Figure 2. First lecture: the quantum coin flip. Schematics of the quantum coin flip “thought” game interpreted in terms of state preparation, evolution and measurement. One coin is initially prepared in a given state (T, i.e., Head here). After a number of flips by either the quantum computer (displayed as a chip) or the human operator, a measurement is performed (here, yielding C, i.e., Tail).

In the second lecture, we introduce the use of the IBM Q-composer [21] to write and execute quantum circuits on simulators and real quantum computers (Figure 3).

EXAMPLE – state measurement

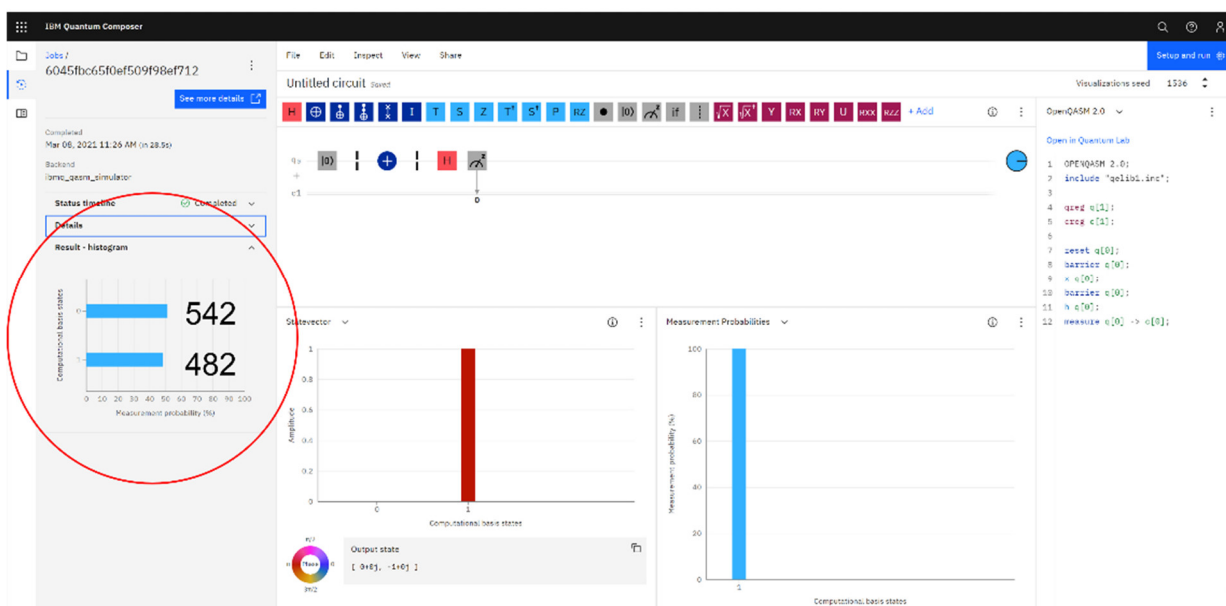

Figure 3. Second lecture: IBM Q-composer interface for programming quantum computers. Example of the quantum coin flip circuit executed on a simulator. In the Q-composer interface, $|0\rangle$ and $|1\rangle$ are the kets representing the computational basis. Center of the graphic interface. **Top:** the row of symbols represents a number of quantum logic operators (quantum gates) that can be picked up to compose the quantum circuit. **Middle:** below the list of operators is the composed circuit: here, to the $|0\rangle$ state an X-not gate (represented by the plus symbol) is applied, followed by an Hadamard gate (H symbol) and a measurement operation (gauge symbol). **Bottom:** representation of the state vector in terms of probability and in the Bloch sphere representation (**left**) and of the measurement probabilities (**right**). A single measurement yields just one of the possible outcomes (1 in this case). The left part of the graphical interface shows an output of a repeated measurement yielding a statistical distribution of the two possible outcomes (in the red circle). The right part of the interface shows Python code corresponding to the quantum circuit. Credits: IBM Q-composer [21].

Quantum mechanical applications require measuring the state of the qubits; thus we introduce the rules of quantum measurement, its epistemological aspects, and its role in the implementation of quantum algorithms. The lecture is supported by the QuVis simulator for a series of Stern–Gerlach apparatuses on spin-1/2 particles (Figure 4) [22].

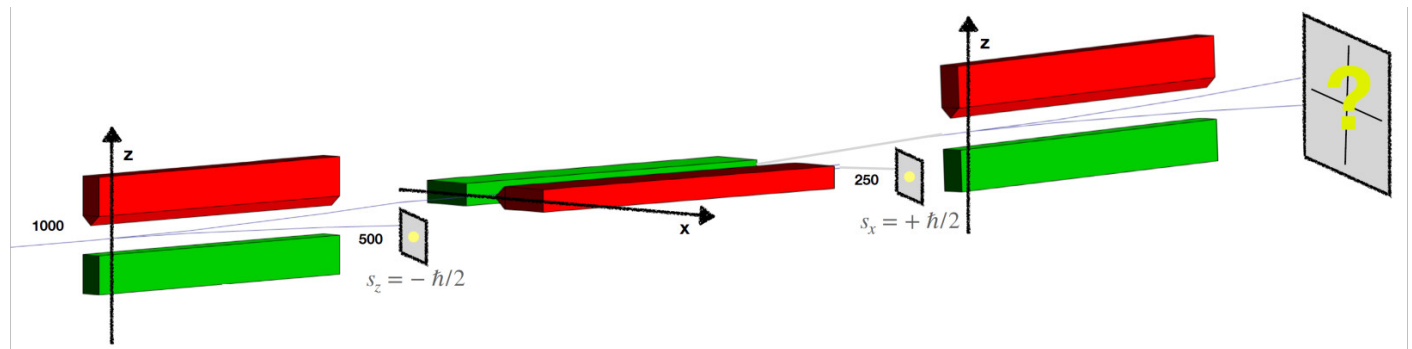

Figure 4. Third lecture: QuVis simulation of Stern–Gerlach experiment. 1000 spins pass through a z-magnet, after which a measurement is performed detecting 500 of the spins in a spin-down state (along z). The remaining spin-up states pass through an x-magnet, after which a measurement is performed detecting half of the spins in a spin-up state (along x). The remaining 250 spins finally pass through a second z-magnet. The students are then asked (notified by a question mark) what they do expect would be the outcome of a measurement, after the latter process. $s_z = -\hbar/2$ and $s_z = +\hbar/2$ define the spin down and up z-components, respectively, and \hbar is the Planck’s reduced constant.

Particular care was paid to describe the role of non-commuting quantum operation and the need to describe the spin state of the particle as a superposition state.

In the third lecture, we address two-qubit states and gates to introduce the concept of entanglement, both from the physical and the algorithmic point of view. The IBM Q-interface is used for the Bell-state circuit.

The relevance of entangled states for quantum technologies is highlighted through the description of the BBM92 protocol for secure cryptographic key generation (Figure 5) and the Schrödinger cat paradox.

Simulation
Step-by-step Explanation
quantumphysics.iop.org
IOP Institute of Physics
QuVis

Quantum key distribution with entangled spin 1/2 particles

Alice

Source of particle pairs

Eve

Bob

In vacuum

Z X
 Random orientations Fixed orientations
 Z X
Introduction

Display controls		Alice		Eve		Bob		Alice and Bob	Key
<input checked="" type="checkbox"/> Show key generation	Basis	Outcome	Basis	Outcome	Basis	Outcome	Same bases?	Bob inverts value	
	Z	0	X	1	Z	0	YES	ERROR	

Figure 5. Third lecture: QuVis simulation of BBM92 cryptographic protocol in the presence of an eavesdropper. Alice and Bob share a source of entangled spin-1/2 particles and measure through Z-magnet or X-magnet to obtain a secret key. The eavesdropper Eve measures the spin state of the transiting qubit toward Bob. Eve cannot measure simultaneously along Z and X and therefore cannot obtain complete information about the spin state of the intercepted qubit. When Eve resends the qubit to Bob the spin can be different from the original one; for details, see [23].

The fourth lecture is devoted to a general recap of the concepts introduced in the first three lectures to stress the overall rationale and the links among them. A part of the final lecture introduces the Einstein-Podolsky-Rosen (EPR) paradox and the violation of Bell's inequalities (Figure 6) [24].

quindi ... COS'È un OGGETTO QUANTISTICO?

- una particella? localizzata, indivisibile, numerabile, ...
- un'onda? estesa, divisibile, continua, ...

dibattito sul dualismo onda/particella

È un nuovo tipo di oggetto, con proprietà sue particolari, che sfidano le leggi della fisica classica e il senso comune, ma che possiamo stabilire e utilizzare

I CALZINI DI ERWIN

A casa, Erwin ha una collezione di calzini molto semplice:

- di due forme (LUNGI / CORTI)
- di due colori (NERI/ROSSI)

Soprattutto la mattina appena sveglio, Erwin è molto distratto e quindi ha progettato due macchine che sanno distinguere l'una a forma (F=L, C=R), l'altra il colore (N=RO, R=RU).

Pensa di poter selezionare due calzini uguali, usando prima il selettore di forma F e poi quello di colore C.

Per essere sicuro che la procedura funzioni, ricontrolla la forma dei calzini con il selettore di forma F.

DISUGUAGLIANZE DI BELL - derivazione

Possiamo rappresentare graficamente l'insieme degli studenti, raggruppati a seconda delle proprietà.

DISUGUAGLIANZE DI BELL – stato entangled

Se ora consideriamo il sistema di spin di EPR, noi sappiamo che l'osservazione di una proprietà su uno di essi, consente di prevedere con certezza il risultato dell'osservazione della stessa proprietà sull'altro.

Ad esempio lo spin lungo l'asse z nel caso dello stato di Bell $|\mathcal{Q}\rangle = \frac{1}{\sqrt{2}}(|0\rangle|0\rangle + |1\rangle|1\rangle)$

Figure 6. Fourth lecture: recap of the concepts and discussion of theory interpretations. Screenshots of the slides used during the lecture. **Left:** What is a quantum object? **Right:** concept of properties (**top**) and entanglement (**bottom**).

The second phase of our learning path is devoted to specialized lectures in which quantum technologies are examined from both physical and technological points of view. Three different paths were designed: quantum computing, quantum communications, and quantum mechanics foundations, with the latter organized into the three sub-paths: polarization; time evolution and the measurement paradox; realism and locality.

Finally, in the last phase, the state of art quantum technologies is from the viewpoint of their social and economic impact by examining the appearance of the targeted concepts in the media.

More details on the educational path are included in Appendix A.

1.3. Aims of the Study

This study has a twofold aim: (1) building on the theoretical background described above, to evaluate whether the designed path helped the students to grasp a basic knowledge of fundamental quantum physics; (2) building on the potential attractiveness of the quantum technologies applications, to evaluate whether the designed didactical path improved students' views about quantum technologies. Thus, we posit the following research questions:

To what extent was the educational path on quantum technologies effective in improving the students' knowledge about fundamental quantum mechanics concepts?

To what extent was the educational path on quantum technologies effective in improving the students' views about quantum technologies?

2. Methods and Tools

2.1. Instructional Context

The study was carried out in the context of the Italian plan called Paths for Transversal Competencies and Orientation (PCTO). The PCTO activities are mandatory for students and include either career orientation or vocational practice.

The PCTO activities on quantum technologies here reported came about as a follow-up to the outreach conference on the second quantum revolution organized by the European project QTedu in November 2020. About 2000 students have registered for the conference and more than 3800 have viewed it on YouTube so far [25]. The conference aimed at giving a general introduction to the different quantum technologies that emerged from the first quantum revolution and are emerging from the second one, avoiding overly technical and explicit physical and mathematical content. Building on the success of the conference, we decided to offer Italian high-school teachers and students the opportunity to deepen their knowledge on the topic.

The activities described in this study were carried out in spring 2021 for a total time of about 12 h over a time span of two months, in remote distance modality using the Zoom platform. Lectures were conducted by alternating presentations with simulations and exercises. Student engagement was stimulated by interactive questions and clickers to maintain attention and check their understanding of the content.

2.2. Sample

The sample consisted of $N = 279$ Italian high-school students (females: 24.4%; males: 73.8%; prefer not to say: 1.8%) from 16 different schools distributed across Italy. The course was restricted to students attending the 12th ($N = 101$, average age: 18.0 ± 0.4 s.d. (standard deviation)) and 13th grades ($N = 178$; average age: 19.0 ± 0.5 s.d.). The great majority (82%) of the students attended the Liceo Scientifico (mathematically-oriented high school), about 12% attended an applied science course (natural sciences-oriented high school), and about 6% attended a technical school.

2.3. Instruments

2.3.1. Quantum Technologies Inventory (QTI)

For the present study, we developed a short questionnaire (QTI) featuring eight items on the topics addressed during the educational path. The questionnaire was built on our prior studies [26–29]. The reason for developing such a new instrument is that none of the current instruments for evaluating students' performance in quantum mechanics focuses on the central concepts addressed in our educational path about quantum technologies. Table 1 summarizes the concepts and topics addressed in the questionnaire. The complete questionnaire is reported in Appendix B.

Table 1. The main topics addressed in the quantum technologies inventory (QTI).

Concept	Sub-Topic	Item
State	Bra-Ket Formalism	Q3 Q4 Q7
	State and eigenstate in quantum physics	Q1 Q2 Q3
	Logical gate	Q1
	Qubit	Q3
Superposition		Q1 Q7
Measurement	Statistical nature of the measurement	Q2 Q6 Q8
	Wave function collapse	Q7
Entanglement	Formalism	Q4
	measurement on entangled states	Q5

2.3.2. Views about Quantum Technologies (VAQT)

Five elements were used to measure students’ views about quantum, technologies:

1. Assuming to use ideal measuring instruments, in physics I must describe the results of measurements probabilistically only if I have incomplete information about the system;
2. It is possible for physicists to carefully perform the same experiment and get two very different results that are both correct;
3. Quantum computers will never work, because it is impossible to build an hardware that is accurate enough;
4. Scientists say that quantum communication makes it possible to teleport a particle from one place to another;
5. Scientists say that quantum communication does not make possible the teleportation of a particle from one place to another, but only the transfer of its characteristics.

The elements 1 and 2 address students’ general epistemic views about quantum mechanics, namely ideas about values, assumptions, processes, and formations of knowledge about quantum mechanics [30]. Elements 3–5 address more specific views about quantum technologies applications.

2.4. Data Analysis

The QTI items were scored as follows. Correct answers to two items (Q1, Q3) received 2 points, while one option received 1 point. For item Q8, two answer choices received 1 point. Correct answers to the remaining six items received 1 point, while the remaining options received no credit. The reason for such scoring was that Q1 and Q3 addressed more complex topics that allowed for a more refined scoring, while Q8 had two correct answer choices. The total score for the eight items was therefore 10. The five VAQT items were scored using a 5-point Likert scale.

The QTI was submitted after the teaching activities. The VAQT was submitted before and after the teaching activities. Pre-post differences in the VAQT items were evaluated through a *t*-student test and Cohen’s effect size, *d* [31].

3. Results

Overall, 176 students responded to the QTI after the didactical path, while 162 completed the VAQT instrument before and after the out-of-school activities.

The breakdown of the students’ answers to the eight items of the QTI instrument is given in Table 2. The distribution of the students’ scores is shown in Figure 7.

Table 2. Frequencies of N = 176 students’ responses to the QTI. Correct answer choices are in boldface. See Appendix B for the complete questionnaire.

Answer Choice	Q1	Q2	Q3	Q4	Q5	Q6	Q7	Q8
A	20%	7%	52%	17%	14%	31%	38%	9%
B	36%	30%	15%	40%	18%	10%	22%	5%
C	39%	53%	18%	16%	15%	23%	11%	32%
D	3%	9%	13%	22%	51%	33%	27%	55%
No answer	1%	1%	2%	4%	3%	3%	2%	1%

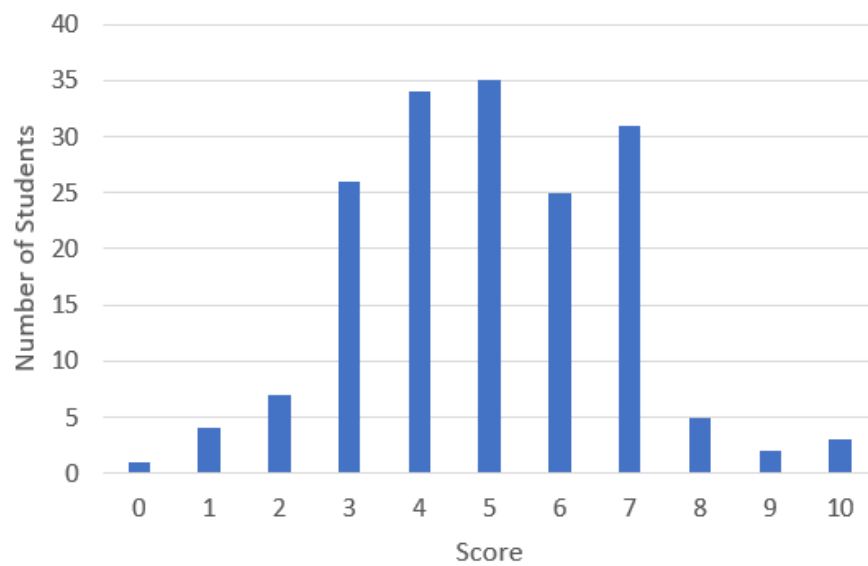

Figure 7. Distribution of students' scores in the quantum technologies inventory (QTI). See text for details.

The average pre-instruction score in the VAQT items about general epistemic aspects was $3.04 \pm .85$ s.d., while the average post-instruction score was 3.40 ± 0.91 s.d. The difference is statistically significant (t -test $t = 4.68$, degrees of freedom $df = 160$, probability $p < 0.001$), with a medium effect size (Cohen's $d = 0.37$) [31]. The average pre-instruction score in the VAQT items about quantum technologies applications was 3.43 ± 0.74 s.d., while the average post-instruction score was 3.65 ± 0.80 s.d. The difference is statistically significant ($t = 3.35$, $df = 160$, $p < 0.001$), with a medium effect size (Cohen's $d = 0.26$).

To better understand this trend, we divided the sample into four groups according to their performance and then calculated the effect size of the difference between the post and pre-test for the VAQT items for each group. Figures 8 and 9 show the average pre-instruction and post-instruction scores for each group, while Table 3 gives the corresponding Cohen's d .

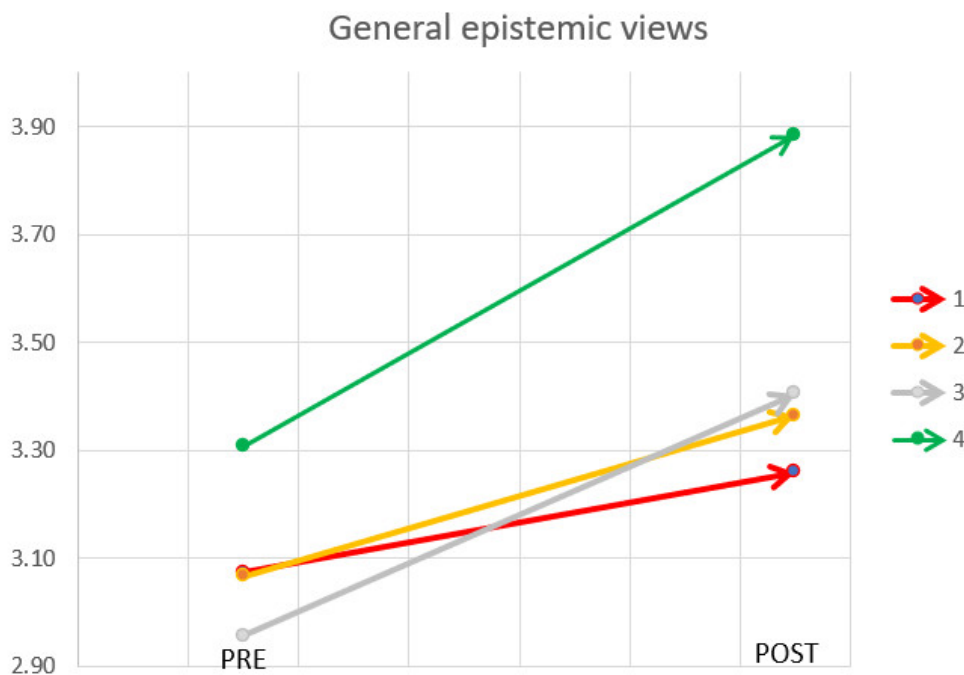

Figure 8. Pre-instruction vs. post-instruction average scores of the views about quantum technologies (VAQT) instrument (general epistemic views) according to the performance in the QTI for four groups (see Table 3).

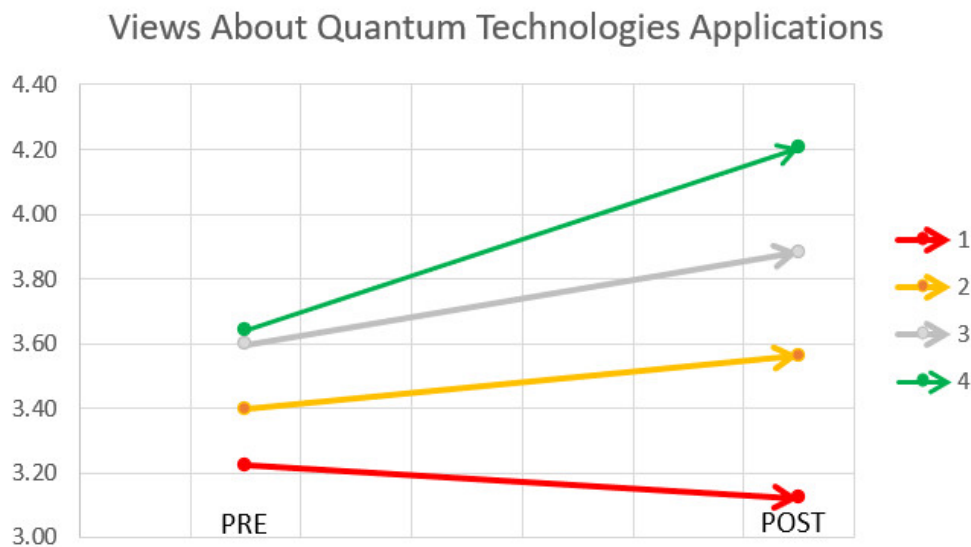

Figure 9. Pre-instruction vs. post-instruction average scores of the VAQT instrument (applications of quantum technologies) according to the performance in the QTI for four groups (see Table 3).

Table 3. Sample subdivision and pre-post effect size for the views about quantum technologies (VAQT) instrument according to QT performance score.

Group	QTI Score	Number of Students (N = 162)	Cohen’s <i>d</i>	
			General epistemic views	QT applications
G1	0–3	25	0.23	−0.14
G2	4–5	71	0.36	0.22
G3	6–7	56	0.49	0.38
G4	8–10	10	0.54	0.96

4. Discussion and Conclusions

The analysis of the students’ answers to the QTI shows that, on average, the educational path was useful to familiarize students with fundamental aspects of quantum mechanics. Considering the fact that this was the first time the students tackled central concepts of quantum theory, the educational path was effective in focusing students’ attention on the fundamental concepts of quantum mechanics through the parallelism of information theory. About 40% of the students show a good knowledge of the measurement concept and of the wave function collapse, as measured by the QTI items. Similarly, on average, about 45% of the students seem to have grasped the concept of entanglement, which is not included in the national curriculum. Only about one-third of the students correctly answered questions about the state and superposition. However, the students found it difficult to apply formal calculations to states represented as qubits. On such a basis, we are currently revising our educational path to improve the presentation of the concepts of state, qubit, and superposition. We also plan to improve the instruments used to assess the effectiveness of the proposed activities.

From the analysis of the students’ responses to the VAQT, it emerges that, on average, the proposed path was effective in letting students acquire more informed views about general epistemic aspects of quantum mechanics and quantum technology applications. Greater gains, as measured by the Cohen’s *d* effect size, were shown by the students who performed better on questions about the fundamental concepts of quantum mechanics. Such a result suggests a link between the knowledge of quantum physics concepts and informed views about epistemic aspects. However, more research is warranted to investigate such a relationship in more detail.

Limitations of the study include the involvement of a small sample and the remote distance modality of the didactical activities. Results are also limited by the use of instruments not yet validated. Oral interviews would have improved the reliability of our findings. We plan to revise both instruments and perform a more rigorous study of their validity and reliability.

Overall, the present study shows that the proposed educational path may be effective in helping students grasp fundamental quantum concepts, acquire informed views about how knowledge in quantum mechanics is constructed, and familiarize them with applications of quantum technologies.

The first implementation of our didactical path is encouraging and may help other researchers interested in quantum mechanics education to implement similar activities. While promising, our results also point out that initial motivation toward physics is crucial to grasping the addressed concepts. This evidence calls for a stricter collaboration with schoolteachers with the aim to share the key ideas and didactical objectives of the activities. With this in mind, a second run of PCTO activities was performed in spring 2022 with a very similar program but with fewer students attending. Data analysis is ongoing. Moreover, the same approach to quantum physics, more focused on basic concepts, presentation of axioms, and quantum technologies was adopted by the outreach project “Italian Quantum Weeks” (2022–2024) [32] devoted to students and the general public.

Author Contributions: Conceptualization, M.B., M.M. (Massimiliano Malgieri), P.O. and I.T.; methodology, M.B., M.M., P.O. and I.T.; software, M.B., F.P., S.S. and G.Z.; validation, M.L.C., E.E., C.M., O.M., A.S., C.S. and G.Z.; formal analysis, P.O. and I.T.; investigation, M.B., M.M. (Massimiliano Malgieri) and I.T.; resources, O.M.; data curation, P.O. and I.T.; writing—original draft preparation, M.B. and I.T.; writing—review and editing, M.L.C., E.E., C.M., M.M. (Massimiliano Malgieri), M.M. (Marisa Michelini), O.M., P.O., F.P., S.S., A.S., C.S., I.T. and G.Z.; visualization, M.B.; supervision, M.B., M.M., P.O. and I.T.; project administration, M.B.; funding acquisition, M.B. All authors have read and agreed to the published version of the manuscript.

Funding: This research received no external funding.

Data Availability Statement: The data presented in this study are available on request from the corresponding author. The data are not publicly available due to privacy issues.

Conflicts of Interest: The authors declare no conflict of interest.

Appendix A. Path Description

Appendix A.1. Plenary Introductory Lectures

- **Lecture 1** Objective: quantum state, superposition state Content: qubits, Dirac representation, role of probability in quantum mechanics
 1. Classical and quantum coin-flipping game
 2. How to describe a quantum coin: bits and qubits
 - Dirac notation
 - Superposition states
 - Visual representation of qubits (Bloch sphere)
 3. Operations on quantum coin: single qubit quantum logic gates
 - I, NOT, Z, H
 4. Physical examples of qubits
 - Single photon after a beam splitter (QuVis, MILQ [33])
 - Electronic spin
 - Cavity atom
 - Superconducting circuits
- **Lecture 2** Objective: measurement Content: representation of quantum measures, role of probability, non-compatible measurements
 1. Introduction to IBM Quantum experience

- again on the logic of H, NOT, Z, X, and exercises on IBMQ
 - definition of coefficients of superposition states (probability amplitude), probability, and measurement
2. Stern–Gerlach experiment
 - simulated experiments for sequences of Stern–Gerlach apparatuses performed using QuVis
 - discussion on the logical necessity of describing the spin state of the electron as a superposition state
 3. Experiments with QuVis
 - difference between mixtures and superposition states
 - sequence of three Stern–Gerlach apparatuses
- **Lecture 3** Objective: entanglement Content: separable and entangled states, correlated measurements
 1. Introduction
 - two-qubit states (basis elements, normalization)
 - difference between entangled state and separable state
 - measurement of single qubits in many-qubit states
 - Bell states: invariance upon basis rotation
 - reprise of Stern–Gerlach experiments to discuss the value of reality to be attributed to the variables
 2. IBMQ interlude
 - quantum circuit to generate entangled states
 3. Application of entanglement
 - QuVis: cryptographic protocol BBM92
 4. Historical contextualization
 - Einstein-Podolsky-Rosen (EPR) paradox (Schrödinger’s cat): locality and realism
 - Bell’s inequalities: classical correlations vs entanglement
 - QuVis: cryptographic protocol BBM92
 - **Lecture 4** Objective: synthesis of concepts and formalism Content: axiomatic conceptual framework of quantum mechanics, interpretative problems
 1. Summary of the concepts discussed in the previous lectures
 - highlight the connections among the concepts
 - introduce concepts intentionally not mentioned in the lectures but that the students will encounter in their course of study: uncertainty principle, wave function, dualism
 2. Interpretative problems in quantum mechanics
 - EPR paradox
 - Bell’s inequalities

Appendix A.2. Specific Paths

- **Quantum computing** (Figure A1)

Objective: basics of quantum computing
Content: quantum gates, quantum algorithms, teleportation, quantum random walk

Porte logiche ad un qubit

Esempio: NOT quantistico X



in	Out
$ 0\rangle$	$X 0\rangle = 1\rangle$
$ 1\rangle$	$X 1\rangle = 0\rangle$
$ Q\rangle = a 0\rangle + b 1\rangle$	$X Q\rangle = b 0\rangle + a 1\rangle$

Esempio: gate Z



in	Out
$ 0\rangle$	$Z 0\rangle = 0\rangle$
$ 1\rangle$	$Z 1\rangle = - 1\rangle$
$ Q\rangle = a 0\rangle + b 1\rangle$	$Z Q\rangle = a 0\rangle - b 1\rangle$

Porte logiche ad un qubit

Esempio: gate Hadamard H

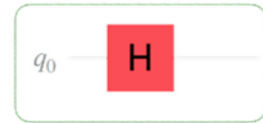

in	OUT
$ 0\rangle$	$H 0\rangle = +\rangle = \frac{1}{\sqrt{2}} 0\rangle + \frac{1}{\sqrt{2}} 1\rangle$
$ 1\rangle$	$H 1\rangle = -\rangle = \frac{1}{\sqrt{2}} 0\rangle - \frac{1}{\sqrt{2}} 1\rangle$
$ Q\rangle = a 0\rangle + b 1\rangle$	$H Q\rangle = \frac{a+b}{\sqrt{2}} 0\rangle + \frac{a-b}{\sqrt{2}} 1\rangle$

Sistemi composti: porte a due qubit



in	out
$ 00\rangle$	$ 00\rangle$
$ 01\rangle$	$ 01\rangle$
$ 10\rangle$	$ 11\rangle$
$ 11\rangle$	$ 10\rangle$

Teleportation

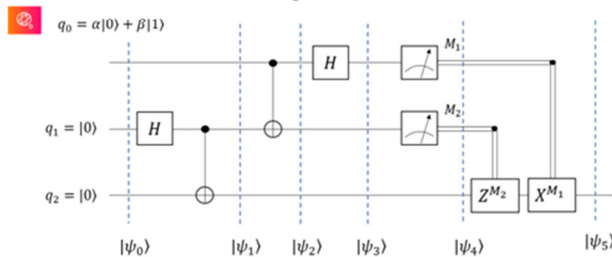

Random Walk Quantistico - Matematica

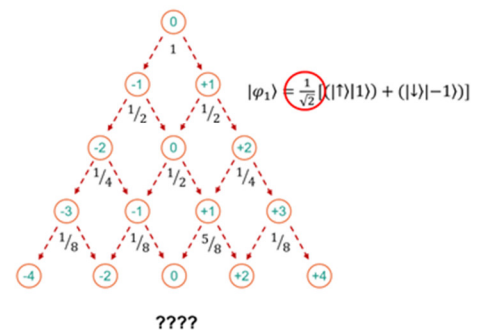

Figure A1. Examples from the specific path “Quantum computing”. Screenshots of the slides used during the lecture. **Top**: single-qubit gates. **Left middle**: two-qubit gates. **Left bottom**: teleportation protocol. **Right-bottom**: one step of the mathematical description of the quantum random walk protocol.

- **Quantum information** (Figure A2)

Objective: basics of quantum information

Content: classical and quantum cryptography, cryptographic protocols, quantum random number generation for cryptography

Quantum random number generator

Un generatore quantistico di numeri casuali si basa su un processo fisico la cui casualità è garantita dalle leggi della Meccanica Quantistica.

Esempi di tali processi sono:

- Misura di un singolo fotone a valle di un beam splitter: stato di sovrapposizione di cammini
- Misura di un singolo fotone polarizzato a 45° a valle di un beam splitter

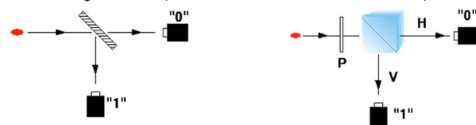

- Decadimenti nucleari
- Emissione di singoli atomi/molecole

Figure A2. Examples from the specific path “Quantum information”. **Left**: BB84 protocol implemented on QuVis. **Right**: example of implementation of a random number generator with single photons.

- **Fundamentals: Polarization (Figure A3)**

Objective: understand basic principles

Content: state, properties, superposition principle, entanglement

I fondamenti della MQ nel contesto della polarizzazione della luce

MECCANICA QUANTISTICA
 Capire i principi base
 * **STATO**
 * **PROPRIETA'**
 - Mutuamente esclusive
 - Incompatibili [e principio di indeterminazione]
 • **PRINCIPIO DI SOVRAPPOSIZIONE** e relative conseguenze
 • **ENTANGLEMENT**
 • **Inammissibilità della traiettoria** (natura non locale della MQ)

Le caratteristiche dei fenomeni e le relative interpretazioni
[Fisica quantistica \(uniud.it\)](http://Fisica.quantistica.uniud.it)

Filtri polaroid sovrapposti in direzioni diverse: scoperta di una nuova proprietà

Fotoni polarizzati verticalmente
 Fotoni incidenti polarizzati verticalmente
 Passano tutti
Proprietà Δ
Stato v
 Fotoni incidenti polarizzati verticalmente
 Non ne passa alcuno
 Polaroid con direzione permessa verticale
 Polaroid con direzione permessa orizzontale
 Fotoni incidenti polarizzati verticalmente
 Ne passa in media la metà
 Polaroid con direzione permessa a 45°

Fotoni polarizzati orizzontalmente
Proprietà $*$
Stato o
 Fotoni incidenti polarizzati orizzontalmente
 Non ne passa alcuno
 Polaroid con direzione permessa verticale
 Fotoni incidenti polarizzati orizzontalmente
 Ne passa in media la metà
 Polaroid con direzione permessa a 45°
 Fotoni incidenti polarizzati orizzontalmente
 Passano tutti
 Polaroid con direzione permessa orizzontale

Proprietà incompatibili e stato di sovrapposizione u+v
 Fotoni incidenti polarizzati a 45°
 Ne passa la metà
 Polaroid con direzione permessa verticale
 Fotoni incidenti polarizzati a 45°
 Ne passa la metà
 Polaroid con direzione permessa orizzontale
Fotoni polarizzati a 45°
 Fotoni incidenti polarizzati a 45°
 Polaroid con direzione permessa a 45°
Quale proprietà? Quale stato?

Figure A3. Examples from the specific path “Fundamentals: Polarization”. Screenshots of the slides used during the lectures. **Top left:** summary of the lectures. **Top right:** examples of polaroid superposition. **Bottom:** schematics of the behavior of polarized photons passing through polaroid filters.

- **Fundamentals: Measurement Paradox (Figure A4)**

Objective: evolution of quantum systems and measurement

Content: the laws of quantum mechanics, logic gates, Schrödinger’s cat

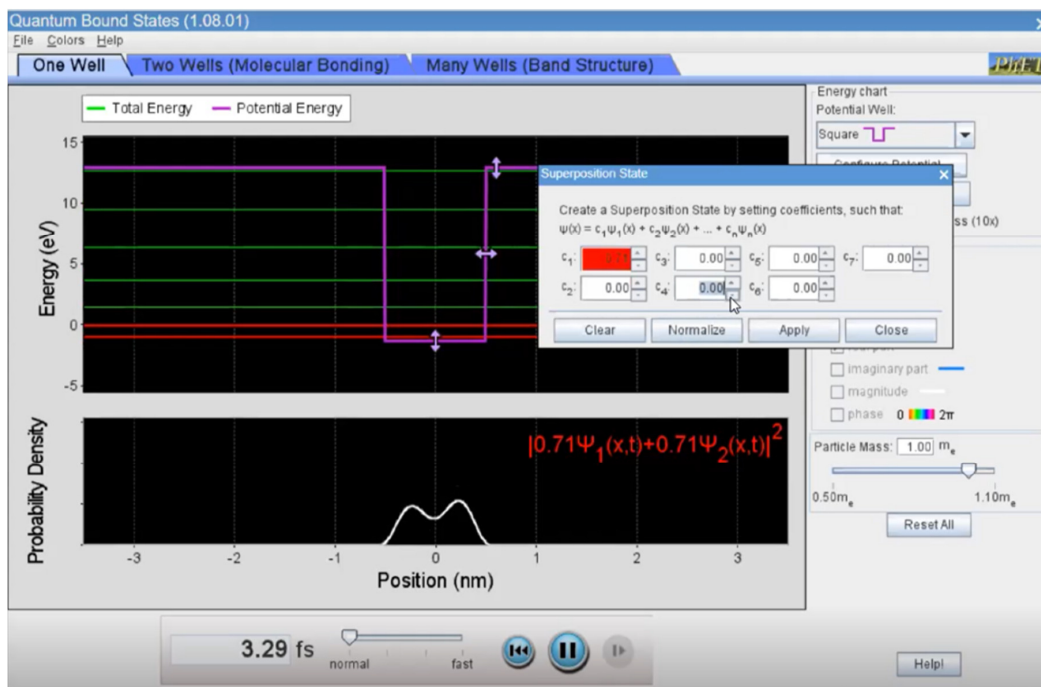

Figure A4. Examples from the specific path “The measurement paradox: Schrödinger’s cat and other fantastic beasts (and where to find them)”. Before comparing system evolution governed by the Schrödinger equation and evolution in measurement, students are led to use a PhET simulation in order to elicit qualitative properties of the former.

- **Fundamentals: Realism and Locality** (Figure A5)

Objective: discussion of interpretative problems in quantum mechanics
 Content: EPR paradox, hidden variable theories, Bell’s inequalities

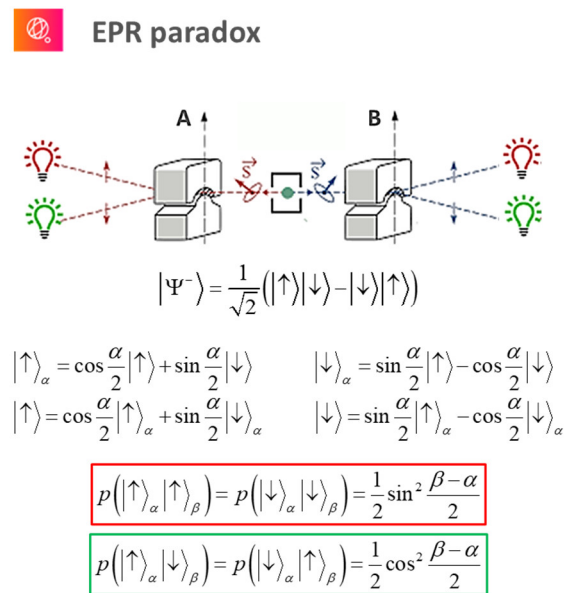
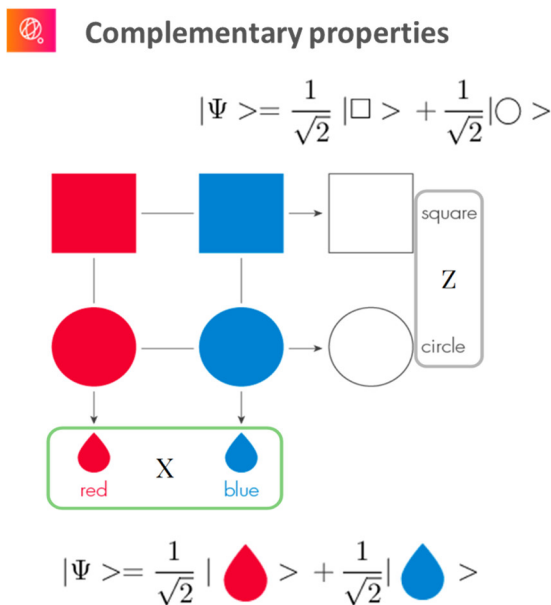

Figure A5. Examples from the specific path “Fundamentals: Realism and locality”. Left panel: pictorial representation of complementary properties. Right panel: scheme of the EPR paradox experiment and mathematical description of the entangled state and the values of detection probabilities for complementary measurements.

Appendix A.3. Final Lecture (Figure A6)

Objective: social and cultural relevance of the second quantum revolution

Content: presentation of the current debate and the implications of the second quantum revolution at national and international levels through newspaper articles and official documents (e.g., Quantum Manifesto) description of present quantum technologies, description of new jobs in quantum technologies.



Figure A6. Examples from the final lecture. Screenshots of the slides used during the lecture. Top left: timeline of quantum computer technology. Top right and bottom-left: examples of newspaper titles on quantum computers. Bottom-right: image from the website of the Quantum Technology Flagship.

Appendix B. Quantum-Technologies (QT) Questionnaire

We report in boldface the correct answers (see Table 2). The percentage for each answer choice is also reported. Note: "NR" denotes "not responded".

Q1. A quantum state prepared in a $|0\rangle$ state undergoes a transformation (logic gate, beam splitter, magnetic field acting on the spin) but no measurement is made on the system. Will the resulting state after the transformation (final state) be uniquely determined? (NR = 1%):

- (a) Yes. Knowing how the transformation changes the initial state, the final state is uniquely determined (20%)
- (b) No. You could get different states because the transformation might not end up on a well-defined state $|0\rangle$ or $|1\rangle$ but on an intermediate state (36%)
- (c) No, because I can obtain states with different probability defined by the superposition coefficients (39%)
- (d) Yes, the state remains the same regardless the transformation (3%)

Q2. To "know" the state of a quantum system implies that we are able to predict: (NR = 1%):

- (a) the outcome of any measure on the system with certainty (7%)
- (b) the outcome of a single measurement of any observable within the limits set by the uncertainty principle (30%)
- (c) the probability of different outcomes of any given measure on the system (53%)
- (d) the state a system after any measurement process with certainty (9%)

Q3. A single qubit is on a superposition state $|Q\rangle = a|0\rangle + b|1\rangle$ and no measurement is performed. That means (NR = 2%):

- (a) The state of the single qubit $|Q\rangle$ is $|0\rangle$ with probability $p_0 = |a|^2$ or $|1\rangle$ with probability $p_1 = |b|^2$ (52%)
- (b) The state of the single qubit $|Q\rangle$ is different from both $|0\rangle$ and $|1\rangle$ (15%)
- (c) The state of the single qubit $|Q\rangle$ is both $|0\rangle$ and $|1\rangle$ (18%)
- (d) The state of the single qubit $|Q\rangle$ oscillates between $|0\rangle$ and $|1\rangle$ (13%)

Q4. Considering these two-qubit states $|\Psi_1\rangle = 1/\sqrt{2}(|0\rangle|1\rangle + |1\rangle|0\rangle)$ and $|\Psi_2\rangle = 1/\sqrt{2}(|0\rangle|0\rangle - |1\rangle|1\rangle)$. We can then say that (NR = 4%):

- (a) $|\Psi_1\rangle$ is separable (can be factorized), $|\Psi_2\rangle$ is entangled (17%)
- (b) $|\Psi_2\rangle$ is separable (can be factorized), $|\Psi_1\rangle$ is entangled (40%)
- (c) Both states are separable (can be factorized) (16%)
- (d) Both states are entangled states (22%)

Q5. Consider a system made of two parts A and B (e.g., two electrons and two photons), that is in an entangled state (e.g., of spin or polarization). Having performed a spin or polarization measurement on A and noted the result, we can deduce that (NR = 3%):

- (a) The same measurement made on system B gives the same result (14%)
- (b) The same measurement made on system B gives the opposite result (19%)
- (c) We will be able to predict with certainty the outcome of any measurement made on system B (15%)
- (d) We will be able to predict with certainty the outcome of the same measurement made on system B (51%)

Q6. Consider the following two probabilistic predictions. Prediction 1) In the classic coin toss, the outcome "head" has probability $1/2$ to occur. Prediction 2) The interaction of a quantum system with a measurement device can only result in two outcomes (e.g., spin $|\downarrow\rangle$ or $|\uparrow\rangle$, vertical or horizontal polarization), each with probability $1/2$. Why is it that in both cases the only predictions we are capable of making are probabilistic? (NR = 3%):

- (a) In prediction (1), we do not know the initial conditions precisely enough. In prediction (2) even if the initial conditions are known, the outcome of the interaction is inherently uncertain. (31%)
- (b) In both predictions, we do not know the initial conditions precisely enough (10%)
- (c) In prediction (1), we do not know the initial conditions precisely enough. In prediction (2) even if the initial conditions are known, we do not know how the interaction works precisely enough (23%)
- (d) To be able to make non-probabilistic predictions, in both cases we would need to have perfect control of the experiment, which is not currently possible (33%)

Q7. Assume that a spin measurement is made on the electron in the spin state $|\Psi\rangle = 1/\sqrt{2}(|\uparrow\rangle_z + |\downarrow\rangle_z)$ along the Z direction is \uparrow , i.e., $s_z = +\hbar/2$. What can I say about its spin along Z before measurement? (NR = 2%):

- (a) it had no defined value (38%)
- (b) it was \uparrow already, but the experimenter didn't know (22%)
- (c) it was zero (11%)
- (d) it was \downarrow the 50% of the time and \uparrow the 50% of the time (27%)

Q8. Regarding the predictability of the outcome of a measurement in quantum mechanics, which of the following statements is correct? More than one correct answer is possible (NR = 0.5%):

- (a) the outcome of a measurement is always unpredictable (9%)
- (b) the outcome of a measurement is always predictable (5%)
- (c) the outcome of a measurement is predictable with certainty when the process of preparation and of measure are related to the same observable of the system (32%)
- (d) the outcome of the measurement process is always predictable only in terms of the probability of outcomes and never with certainty (54%)

References

1. Fox, M.F.; Zwickl, B.M.; Lewandowski, H.J. Preparing for the quantum revolution: What is the role of higher education? *Phys. Rev. Phys. Educ. Res.* **2020**, *16*, 020131. [CrossRef]
2. H.R.6227—National Quantum Initiative Act. Available online: <https://www.congress.gov/bill/115th-congress/house-bill/6227> (accessed on 1 September 2022).
3. Raymer, M.G.; Monroe, C. The US National Quantum Initiative. *Quant. Sci. Technol.* **2019**, *4*, 020504. [CrossRef]
4. Riedel, M.; Kovacs, M.; Zoller, P.; Mlynek, J.; Calarco, T. Europe's Quantum Flagship Initiative. *Quant. Sci. Technol.* **2019**, *4*, 020501. [CrossRef]
5. Ayene, M.; Kriek, J.; Damtie, B. Wave-particle duality and uncertainty principle: Phenomenographic categories of description of tertiary physics students' depictions. *Phys. Rev. ST-PER* **2011**, *7*, 020113. [CrossRef]
6. Ke, J.-L.; Monk, M.; Duschl, R. Learning introductory quantum physics: Sensori-motor experiences and mental models. *Int. J. Sci. Educ.* **2005**, *27*, 1571–1594. [CrossRef]
7. Johnston, I.D.; Crawford, K.; Fletcher, P.R. Student difficulties in learning quantum mechanics. *Int. J. Sci. Educ.* **1998**, *20*, 427–446. [CrossRef]
8. Manilla, K.; Koponen, I.T.; Niskanen, J.A. Building a picture of students' conceptions of wave- and particle-like properties of quantum entities. *Eur. J. Phys.* **2002**, *23*, 45–53. [CrossRef]
9. Tsapalis, G.; Papaphotis, G. Quantum-chemical concepts: Are they suitable for secondary students? High-school students' conceptual difficulties and attempts at conceptual change: The case of basic quantum chemical concepts. *Chem. Educ. Res. Pract. Eur.* **2002**, *3*, 129–144. [CrossRef]
10. Tsapalis, G.; Papaphotis, G. High-school students' conceptual difficulties and attempts at conceptual change: The case of basic quantum chemical concepts. *Int. J. Sci. Educ.* **2009**, *31*, 895–930. [CrossRef]
11. Marshman, E.; Singh, C. Framework for understanding the patterns of student difficulties in quantum mechanics. *Phys. Rev. ST Phys. Educ. Res.* **2015**, *11*, 020119. [CrossRef]
12. Krijtenburg-Lewerissa, K.; Pol, H.J.; Brinkman, A.; van Joolingen, W.R. Insights into teaching quantum mechanics in secondary and lower undergraduate education. *Phys. Rev. Phys. Educ. Res.* **2017**, *13*, 010109. [CrossRef]
13. Singh, C.; Marshman, E. Review of student difficulties in upper-level quantum. *Phys. Rev. ST Phys. Educ. Res.* **2015**, *11*, 020117. [CrossRef]
14. Kalkanis, G.; Hadzidaki, P.; Stavrou, D. An instructional model for a radical conceptual change towards quantum mechanics concepts. *Sci. Educ.* **2003**, *87*, 257–280. [CrossRef]
15. Bouchée, T.; de Putter-Smits, L.; Thurlings, M.; Pepin, B. Towards a better understanding of conceptual difficulties in introductory quantum physics courses. *Stud. Sci. Educ.* **2022**, *58*, 183–202. [CrossRef]
16. Stefani, C.; Tsapalis, G. Students' levels of explanations, models, and misconceptions in basic quantum chemistry: A phenomenographic study. *J. Res. Sci. Teach.* **2009**, *46*, 520–536. [CrossRef]
17. Satanassi, S. The challenge of Quantum Manifesto for science education: Designing a teaching module on quantum computers for secondary school students. *Il Nuovo Cim.* **2020**, *43*, 130. [CrossRef]
18. Mermin, N.D. *Quantum Computer Science—An Introduction*; Cambridge University Press: Cambridge, UK, 2007. [CrossRef]
19. Satanassi, S.; Fantini, P.; Spada, R.; Levrini, O. Quantum Computing for high school: An approach to interdisciplinary in STEM for teaching. *J. Phys. Conf. Ser.* **2019**, *1929*, 012053. [CrossRef]
20. Satanassi, S.; Ercolessi, E.; Levrini, O. Designing and implementing materials on quantum computing for secondary school students: The case of teleportation. *Phys. Rev. Phys. Educ. Res.* **2022**, *18*, 010122. [CrossRef]
21. IBM Quantum. Available online: <https://quantum-computing.ibm.com/> (accessed on 1 September 2022).
22. Sakurai, J.-J.; Napolitano, J. *Modern Quantum Mechanics*; Cambridge University Press: Cambridge, UK, 2020. [CrossRef]
23. Uncertainty of Spin Measurement Outcomes. Available online: https://www.st-andrews.ac.uk/physics/quvis/simulations_html5/sims/MeasurementUncertainty/measurement-outcome-uncertainty.html (accessed on 1 September 2020).
24. Bell, J.S. *Speakable and Unsayable in Quantum Mechanics*; Cambridge University Press: Cambridge, UK, 2004. [CrossRef]
25. La Seconda Rivoluzione Quantistica: Presente e Futuro Delle Tecnologie Quantistiche. Available online: https://www.youtube.com/watch?v=_LoWS0MBTu8&t=448s (accessed on 1 September 2022).
26. Michelini, M.; Zuccarini, G. University students' reasoning on physical information encoded in quantum state at a point in time. In Proceedings of the 2014 Physics Education Research Conference, Minneapolis, MN, USA, 30–31 July 2014; pp. 187–190. [CrossRef]
27. Michelini, M.; Stefanel, A. A path to build basic Quantum Mechanics ideas in the context of light polarization and learning outcomes of secondary students. *J. Phys. Conf. Ser.* **2021**, *1929*, 012052. [CrossRef]
28. Scotti di Uccio, U.; Colantonio, A.; Galano, S.; Marzoli, I.; Trani, F.; Testa, I. Design and validation of a two-tier questionnaire on basic aspects in quantum mechanics. *Phys. Rev. Phys. Educ. Res.* **2019**, *15*, 010137. [CrossRef]
29. Zuccarini, G. Analyzing the structure of basic quantum knowledge for instruction. *Am. J. Phys.* **2020**, *88*, 385–394. [CrossRef]
30. Chiou, G.-L.; Lee, M.-H.; Tsai, C.-C. High school students' approaches to learning physics with relationship to epistemic views on physics and conceptions of learning physics. *Res. Sci. Technol. Ed.* **2013**, *31*, 1–15. [CrossRef]

-
31. Field, A. *Discovering Statistics Using IBM SPSS Statistics*; SAGE Publications: London, UK, 2013.
 32. Italian Quantum Weeks. Available online: <https://www.quantumweeks.it/> (accessed on 1 September 2022).
 33. MILQ—Teaching Quantum Physics. Available online: <https://www.milq.info/en/> (accessed on 1 September 2022).