



UNIVERSITY OF UDINE

DEPARTMENT OF MEDICAL AND BIOLOGICAL SCIENCES

PHD COURSE IN BIOMEDICAL AND BIOTECHNOLOGICAL SCIENCES

XXVII CYCLE

**Role of Mast cell expressed-BAFF in B cell biology:  
promotion of B cell survival in normal and pathological  
context**

PhD Student:

*Alice Amaranta Ceccaroni*

Supervisor:

*Professor Carlo E. M. Pucillo, MD*

Tutor:

*Francesca Mion, PhD*

---

ACADEMIC YEAR 2014-2015

---

# INDEX

ABSTRACT	4
LIST OF ABBREVIATIONS	6
1. INTRODUCTION	8
1.1. MAST CELLS	9
1.1.1. Mast cell development and biology	11
1.1.2. Mast cell receptors, co-stimulatory molecules and soluble mediators	14
1.1.3. Mast cell activation	17
1.1.4. Mast cells: crosstalk with other immune cells	20
1.1.5. Mast cells and tumors	23
1.2. B CELLS	24
1.2.1. B-cell development and differentiation	25
1.2.2. Maturation and activation of B cells	28
1.2.3. B cells: class switch and somatic hypermutation	32
1.2.4. B cell populations	34
1.3. BAFF: B-CELL ACTIVATING FACTOR	35
1.3.1. BAFF structure	37
1.3.2. BAFF variants	42
1.3.3. BAFF receptors	44
1.3.4. BAFF signaling	47
1.3.5. Role of BAFF on B cell biology	48
1.3.6. BAFF in autoimmunity	49
1.3.7. BAFF in tumors	52
2. AIMS OF THE WORK	55
3. RESULTS AND DISCUSSION	57
3.1. INVESTIGATION OF BAFF PRODUCTION IN MAST CELLS	57
3.1.1. BAFF gene expression in murine and human MCs	57
3.1.2. Effects of IgE-dependent and -independent MC-stimulation on BAFF expression	60
3.1.3. APRIL gene expression in MCs	62
3.1.4. Full-length BAFF production by MCs	64
3.1.5. Regulation of membrane-bound and soluble BAFF production in MCs	66
3.2. ROLE OF MC-PRODUCED BAFF IN THE B/MC CROSSTALK	70
3.2.1. MC-expressed BAFF promotes B cell survival	70
3.2.2. MC-expressed BAFF promotes B cell proliferation	74
3.2.3. Modulation of BAFF-R and TACI expression by MCs	76

---

3.2.4.	MC-expressed BAFF does not affect AID expression in B lymphocytes	78
3.2.5.	BAFF is not involved in MC-induced IL-10-competent B cell expansion	81
3.3.	MC-DERIVED BAFF AND MULTIPLE MYELOMA	83
3.3.1.	MCs of MM patients present strong BAFF expression	83
3.3.2.	BAFF expression is up-regulated by the conditioned medium of myeloma cells	87
3.3.3.	Role of MC-derived BAFF in myeloma cell survival	88
4.	CONCLUSIONS	91
5.	MATERIALS AND METHODS	96
5.1.	Solutions and culture media	96
5.2.	Mice and cell lines	99
5.3.	BMMCs differentiation and activation	100
5.4.	Activation of the human MC lines HMC-1.2 and LAD2	101
5.5.	$\beta$ -hexosaminidase release assay	102
5.6.	Total RNA isolation, RT-PCR and qPCR	102
5.7.	Purification of mouse B cells	103
5.8.	Purification of human B cells	105
5.9.	B/LAD2 co-culture and BrdU assay	105
5.10.	CFSE staining of cell division	106
5.11.	Cytokine ELISA assay	107
5.12.	Co-culture of B lymphocyte with MCs	107
5.13.	Murine B cell activation	109
5.14.	Annexin V/ Propidium iodide assay	110
5.15.	Staining for surface markers	110
5.16.	Preparation of protein extracts	112
5.17.	Western blot analysis	112
5.18.	Intracellular staining for IL-10	113
5.19.	MTT assay	113
5.20.	Immunohistochemistry	114
5.21.	Immunofluorescence	115
5.22.	Data analysis	115
6.	REFERENCES	116

## **ABSTRACT**

Mast cells (MCs) are best known for their critical role in allergic response but a growing body of evidence shows that they are important players of a variety of IgE-independent biological processes. It has been demonstrated that MCs are able to interact with B cells and to modulate both their effector and regulatory functions. Since several outcomes of the crosstalk between these two cell types resemble the effects of B-cell activating factor (BAFF), in this work we investigated the possibility that MCs could produce BAFF and we focused on its role in the crosstalk between MCs and B cells. The association between elevated BAFF levels and human autoimmunity and diseases makes the study of the role of BAFF in the B/MC interaction a very intriguing task.

Through experiments of real time PCR we show that both murine and human MCs constitutively express BAFF mRNA. BAFF mRNA expression is associated with protein production both on the cell membrane and in intracellular stores, as demonstrated by flow cytometry and western blot experiments. Conversely, soluble BAFF was not detected, through ELISA, in culture supernatants of both murine and human MCs. Once demonstrated the production of BAFF by MCs, we were interested in elucidating its role in the B/MC crosstalk. Our data show that B cell survival and proliferation are reduced when using BAFF-deficient MCs to perform the MC/B cell co-cultures. On the contrary, BAFF produced by MCs seemed not to be fundamental neither in the induction of activation-induced cytidine deaminase (AID) expression nor in the expansion of regulatory B cells, two processes in which MCs were shown to play an important role. Moreover, we investigated the modulation of the expression of BAFF receptors on B cell surface and we have evidences that BAFF-R and TACI are decreased in the presence of MCs. Finally, we demonstrate that the expression of BAFF by MCs is particularly relevant in the context of multiple myeloma (MM). MCs are known to

infiltrate MM and facilitate new vessel formation. Interestingly, we show that BAFF is absent in the rare MCs present in bone marrow biopsies from healthy subjects while its expression, increases in patients with monoclonal gammopathy of undetermined significance (MGUS) and with MM, following the worsening of the disease. *In vitro* co-culture experiments with the myeloma cell line RPMI 8226 and the human MC line HMC-1.2 suggest that the malignant plasma cells are responsible of the up-regulation of BAFF on MC-surface. In conclusion, our data demonstrate that MCs produce BAFF and uncover an interesting relation between BAFF, B cells and MCs which might result particularly relevant in the context of clonal B cell neoplasias such as MM.

## **LIST OF ABBREVIATIONS**

Ab	Antibody
Ag	Antigen
AID	Activation-Induced cytidine Deaminase
APC	Allophycocyanin
APRIL	A Proliferation-Inducing Ligand
BAFF	B-cell activating factor
BAFF-R	BAFF receptor
BCMA	B cell maturation antigen
BCR	B-Cell receptor
BMMC	Bone Marrow-derived Mast Cell
BrdU	5-bromo-2-deoxyuridine
Breg	B regulatory
CFSE	Carboxyfluorescein Succinimidyl Ester
CSR	Class Switch Recombination
CTMC	Connective Tissue Mast Cell
DC	Dendritic Cell
DNP	Dinitrophenol
FBS	Fetal Bovine Serum
FITC	Fluorescein Isothiocyanate
FO	Follicular
GC	Germinal Center
HSC	Hematopoietic Stem Cell
IFN	Interferon
Ig	Immunoglobulin
IL	Interleukin
LPS	Lipopolysaccharide
mAb	Monoclonal Antibody
MC	Mast Cell
MFI	Mean Fluorescence Intensity
MGUS	Monoclonal Gammopathy of Undetermined Significance
MHC	Major Histocompatibility Complex

MM	Multiple Myeloma
MMC	Mucosal Mast Cell
MZ	Marginal Zone
NF- $\kappa$ B	Nuclear factor kappa-light-chain-enhancer of activated B cells
PBS	Phosphate Buffered Saline
PE	Phycoeritrin
PE-Cy5	Phycoeritrin-Cyanine 5
PI3K	Phosphatidylinositol-4,5-bisphosphate 3-kinase
RA	Rheumatoid Arthritis
RBC	Red Blood Cell
SCF	Stem Cell Factor
SHM	Somatic Hypermutation
SjS	Sjögren's Syndrome
SLE	Systemic Lupus Erythematosus
TACI	Transmembrane activator and CAML interactor
TGF- $\beta$	Transforming Growth Factor- $\beta$
Th	T helper
TLR	Toll Like Receptor
TNF	Tumor Necrosis Factor

## **1. INTRODUCTION**

In the human body one of the principal actors that maintains the balance between “good” and “bad” is the immune system. A really fundamental player in human life, the immune system fights a daily battle against pathogens, it plays an important role in tissue homeostasis and it can also positively or negatively influence tumor growth. The organization is the force of the immune system: many types of cells are orchestrated and guided into the complexity of the human body. The first line of defense includes the skin and the mucosal surfaces, which constitute a barrier against infections. If these barriers are violated the immune system is readily responsive, recruiting specific cell types and leading to specific responses in defense to our body. The immune system is conventionally divided into two parts: the innate (non adaptive) and the acquired (adaptive) immune system. Classically the innate system is the part of the immune machinery that acts in the first line of defense, in which cells recognize and respond to pathogens (Parkin and Cohen, 2001). However, in recent years it has been shown that the role of innate immunity is much more complicated since there is a continuous communication with the adaptive immune system. Indeed, it is increasingly clear that innate and humoral immunity are not two separated compartments, but they continuously communicate and collaborate with each other (Litman et al., 2005). A network of different cell types, both of the innate and of the adaptive immune system, work together and orchestrate the immune response in the human body. Very important is the humoral response which is made by the production of antibodies (Abs) by B cells against different antigens (Ags). This also makes possible the existence of mechanisms of memory that lead to an accelerated response in the case of a subsequent contact with Ags. Also the cooperation between B and T lymphocytes is fundamental for a proper immune response: while B cells



make Abs against soluble Ags, T lymphocytes coordinate the complexity of the immune response.

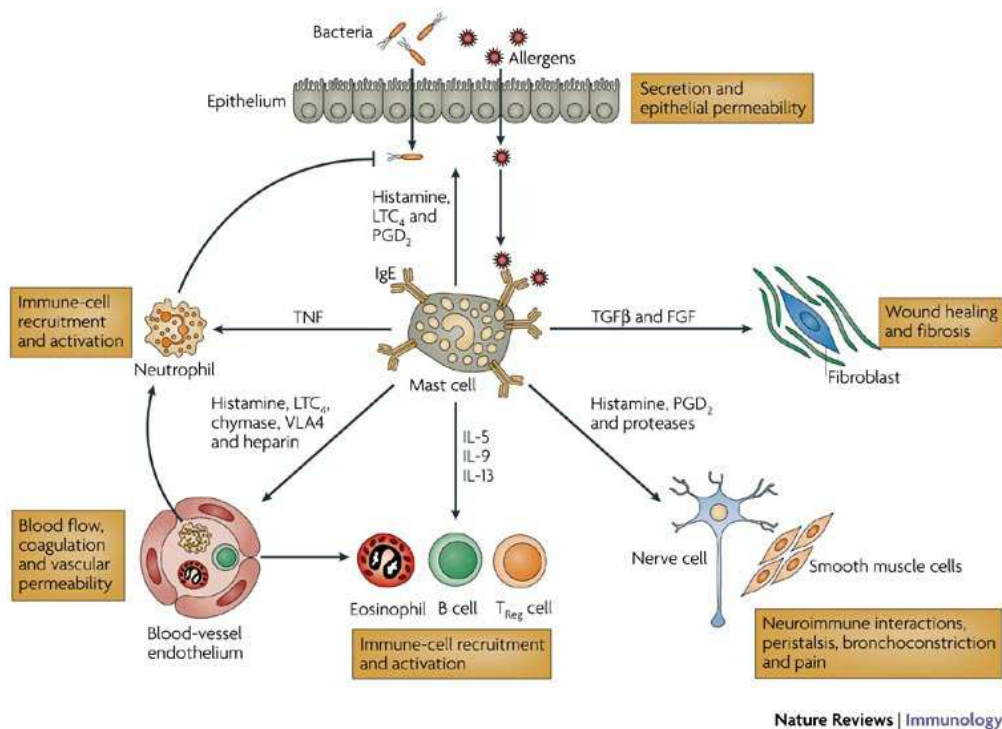
All immune cells originate from hematopoietic stem cells (HSC) located in the bone marrow and differentiate in mature cells under the influence of different cytokines. Cytokines are small signaling proteins that help cells of the immune system by guiding their development and maturation; therefore they are very important to determine the fate of several immune cell types. One of the most important family of cytokines is the Tumor Necrosis Factor (TNF) family. The most important proteins in B cell development belong to this family and one of these, the B-cell activating factor (BAFF), is involved both in physiological processes such as the development and survival of B lymphocytes, and in disease progression.

In light of the relevancy of the communication between the innate and humoral immune system, the interaction between cells that compose this two parts of the immune machinery is gaining increasing interest. In particular, in this work I focused my attention on studying the role of BAFF in the crosstalk between B cells and mast cells (MCs) and its implication in normal and pathological contexts.

## **1.1. MAST CELLS**

In 1878 Paul Ehrlich identified, for the first time, the MC in the human tissue. He defined it “*mastzellen*” (Ehrlich P, 1878; Molderings and Genetics, 2010). Ehrlich named these cells “*mastzellen*” because he speculated that their intracellular granules contained phagocytosed material or nutrients that could be food for neighbor cells (*mast* derives from the greek word *mastos* that means breast). Already at that time, Ehrlich noted that human MCs are usually present as round or elongated cells with a diameter ranging between 8 and 20  $\mu\text{m}$  and that can be found in close proximity of blood vessels and nerves (Ehrlich P, 1878). MCs are traditionally well known for their role in allergy and in the defense against pathogens but

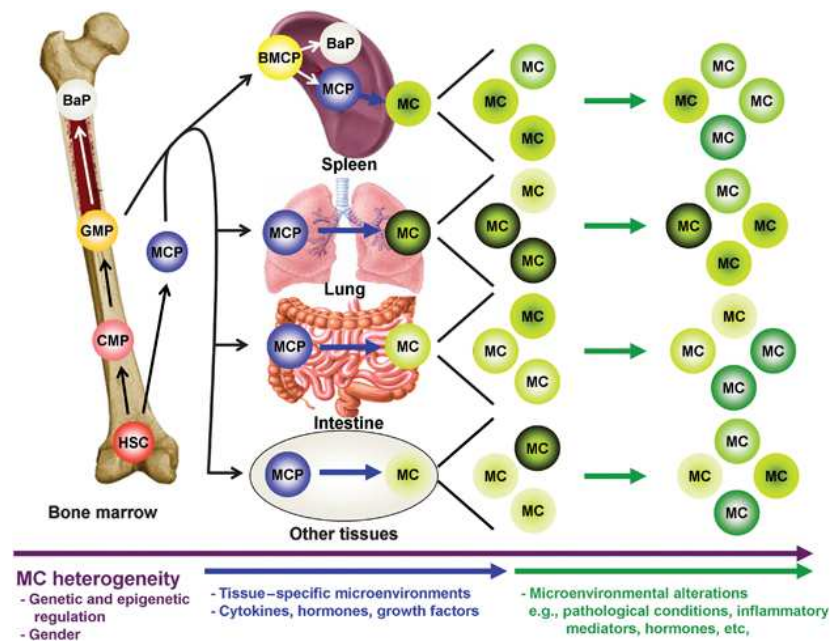
recent studies have shown that MCs play also an important role in the homeostasis of the immune system by interacting with different immune cell types (Gri et al., 2012). MCs are involved in host defense and in the support of cells homeostasis; they are important components of innate immunity, as well as critical effectors in acquired immunity. Therefore, MCs have a versatile physiological function and they should no longer be considered simply as “allergic cells” (Fig.1.2) (Garfield et al., 2006; Maurer et al., 2004). Physiological MC functions include the regulation of epithelial, smooth-muscle and endothelial cells. In addition, MCs affect the recruitment and activation of neutrophils, eosinophils and lymphocytes, and the function of nerve cells and other tissues (Maurer et al., 2003).



**Figure 1.1. Physiological MC functions.** Physiologically, MC functions in the complex immune system include the regulation of epithelial cell functions (secretion and epithelial permeability), smooth-muscle cell functions (peristalsis and bronchoconstriction), and endothelial cell functions (blood flow, coagulation and vascular permeability). Moreover they affect immune functions such as the recruitment and activation of neutrophils, eosinophils and lymphocytes, neuronal functions such as neuroimmune interactions, peristalsis and pain, and other tissue functions (wound healing and fibrosis). The physiological triggers are poorly defined and might include growth and other tissue factors, infectious agents, neuropeptides, protein Ags and physiochemical conditions. (Bischoff, 2007).

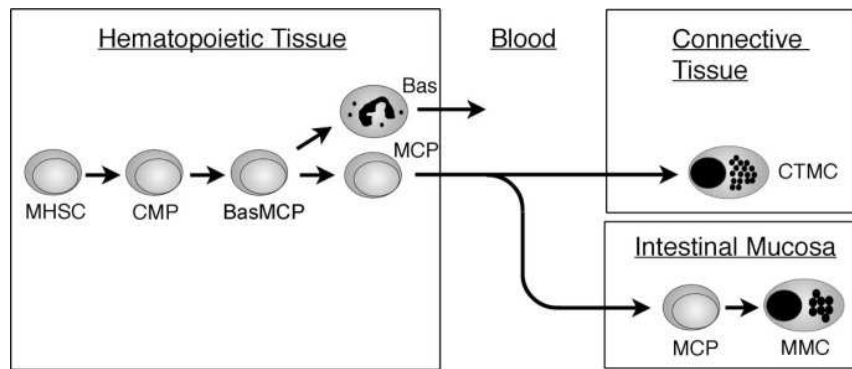
### 1.1.1. Mast cell development and biology

MCs originate in the bone marrow from the  $CD34^+CD13^+CD117^+$  multipotent HSC (MHSC) and then migrate to specific tissues where they complete their maturation (Fig. 1.2) (Hallgren and Gurish, 2011).



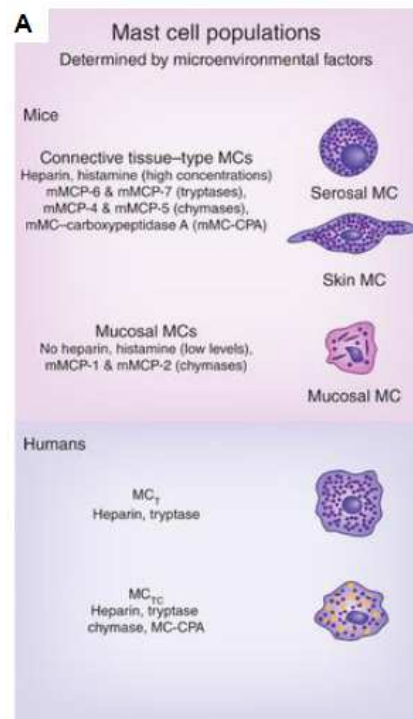
**Figure 1.2. Model of MC development.** MC-development occurs in the bone marrow from a HSC that proceeds along the myeloid lineage through the common myeloid progenitor (CMP) and granulocyte/macrophage progenitor (GMP). MC progenitors (MCP) develop either from GMP or directly from HSC, circulate in the blood stream and finally, migrate into peripheral tissues where they mature (Moon et al., 2010).

Kitamura and colleagues unequivocally established the hematopoietic origin of MCs (Kitamura et al., 1978, 1979a, 1979b, 1993, 2007). Unlike monocytes and neutrophils, MCs circulate in the peripheral blood as immature cell precursors (MCPs) and then enter in peripheral sites where they proliferate and differentiate into morphologically identifiable MCs. In mice, MCs are identified either as connective tissue (CTMC) or mucosal (MMC) MCs (Fig. 1.3).



**Figure 1.3.** Development of MCs from the multipotent HMC. MHSC multipotent HMC, CMP common lymphoid progenitor, MCP MC-committed progenitor, MMC mucosal MC, CTMC connective tissue-type MC (Kitamura et al., 2007).

While CTMCs are found in the skin and peritoneal cavity and express the MC proteases MMCP-4, -5, and -6 and carboxypeptidase, MMCs are mainly present in the intestinal lamina propria and in the lung and are positive for MMCP-1 and -2. MMCs are expanded above all during T cell-dependent immune responses to parasites while CTMCs exhibit little or no T cell dependence (Moon et al., 2010). In the human system, MCs are classified on the basis of the specific serine protease which can be found in their granules: MCs that produce tryptase (MCt) and are predominant in the alveolar septa and in the small intestinal mucosa, MCs that produce chymase (MCc) and are present in the synovial tissue, and MCs that produce both tryptase and chymase (MCtc) and are localized in skin, tonsils and small intestinal submucosa (Fig. 1.4) (Irani and Schwartz, 1994; Irani et al., 1986).



**Figure 1.4. MC populations in humans and mice.** Both in mice and humans, MCs can be subcategorized into populations defined by their anatomical location and/or mediator content, such as proteoglycans or proteases (Adapted from Galli et al., 2011).

An important role in the development and maturation of MCs is played by cytokines such as IL-3, IL-6 and IL-4 (Chen et al., 2005; Kulka and Metcalfe, 2005), but certainly one of the most important signals from tissues for local MCs is stem cell factor (SCF). The receptor that binds SCF on the MC is cKit (or CD117): this receptor is present on hematopoietic lineages early in differentiation, but MCs are the only terminally differentiated hematopoietic cells that still express c-Kit at high levels. Both in human and in mice SCF is a fundamental survival factor. The importance of the SCF:cKit axis in MC-development was understood thanks to the usage of the mouse strains W/W<sup>v</sup>, Sl/Sl<sup>d</sup> and Wsash that have SCF or c-Kit mutations; indeed severe defects in the production of MCs can be observed in these mice (Jarboe and Huff, 1989). Moreover, MCs from patients with systemic mastocytosis exhibit activating mutations in cKit (Akin and Metcalfe, 2004; Akin et al., 2004).

### 1.1.2. Mast cell receptors, co-stimulatory molecules and soluble mediators

The heterogeneity of MCs is dependent on tissue distribution and is reflected by their ability to react to multiple stimuli and to switch numerous Immunoglobulin (Ig) E-dependent and -independent activation pathways (Frossi et al., 2004). MCs respond to many cytokines, chemokines and hormones (Galli et al., 2005a): indeed, they express on their surface a broad array of receptors that regulate MC-activation such as Fc $\epsilon$ RI, Fc $\gamma$ , Toll like receptor (TLR), complements receptor, cytokine, hormone chemokine receptor (summarized in table 1.1).

Receptor family	Members	Reference
<b>FcR</b>		
Fc $\epsilon$ R	Fc $\epsilon$ RI	Kinet (1999)
Fc $\gamma$ R	Fc $\gamma$ RI <sup>a</sup> , Fc $\gamma$ RII, Fc $\gamma$ RIII <sup>b</sup>	Malbec and Daëron (2007)
TLR	TLR 1, TLR2, TLR3, TLR4, TLR5, TLR6, TLR7, TLR8, TLR9, TLR10 <sup>a</sup>	Marshal et al. (2009)
MHC	MHC class I, MHC class II	Svensson et al. (1997)
Complement receptor	CR1, CR2, CR3, CR4, CR5, C3aR, C5aR	Füreder et al. (1995)
Cytokine receptor	CD117, IL-1R, IL-3R, IL-10R, IL-12R, INF $\gamma$ R, TGF $\beta$ R	Edling and Hallberg (2007), Moritz et al. (1998), Frossi et al. (2004)
Chemokine receptor	CCR1, CCR3, CCR4, CCR5, CCR7, CXCR1, CXCR2, CXCR3, CXCR4, CXCR6, CX3CR1	Juremalm and Nilsson, (2005)
<b>RECEPTOR FOR ENDOGENOUS MOLECULES</b>		
Histamine receptor	H1/H2/H3/H4 receptor	Sander et al. (2006)
Others	Endothelin-1, neurotensin, substance P, PGE2, adenosine	Galli et al. (2005b)
Adhesion molecules	ICAM-1, VCAM, VLA4, CD226 (DNAM-1), Siglec8, CD47, CD300a, CD72	Hudson et al. (2011), Collington et al. (2011), Sick et al. (2009), Bachelet et al. (2006)
<b>CO-STIMULATORY MOLECULES</b>		
TNF/TNFR family members	CD40L, OX40L, 4-1BB, GITR, CD153, Fas, TRAILR	Juremalm and Nilsson (2005), Nakae et al. (2006), Nakano et al. (2009)
B7 family member	CD28, ICOSL, PD-L1, PD-L2	
TIM family members	TIM1, TIM3	
Notch family members	Notch1, Notch2	

Some molecules have been detected only in studies on human<sup>a</sup> or murine<sup>b</sup> MCs where not indicated, molecules are expressed in both species.

**Table 1.1. MC membrane-bound receptors.** This table shows receptors expressed on MC surface. They are divided into three big families: FcR, receptors for endogenous molecules and for co-stimulatory molecules. This variety of membrane-bound receptors can regulate MC-activation. (Gri et al., 2012).

The membrane-bound receptors expressed by MCs are divided principally into three categories: Fc receptors (FcR), receptors for endogenous molecules and co-stimulatory molecules. Among the family of FcR, we find the high affinity IgE receptor, Fc $\epsilon$ RI, that leads to the classical MCs activation after binding of high-affinity IgE (See paragraph 1.13) (Kinet, 1999). MCs also express TLR, that lead to an IgE-independent activation of these cells. Human MCs express TLR1, TLR2, TLR3m, TLR4, TLR6 and TLR9 but not CD14 or

functional CD48 (Marshall, 2004). MCs respond to the binding of TLR ligands by secreting cytokines, chemokines, and lipid mediators and some studies have found that TLR ligands can also cause degranulation, although this finding is contentious (Hofmann and Abraham, 2009). In addition, stimulation via TLR can synergize with signaling via the FcεRI, potentially enhancing the response of the cells to Ag *in vivo* (Sandig and Bulfone-Paus, 2012). MCs also express major histocompatibility complex (MHC) class I and II molecules; in particular, the expression of the MHC class II receptor granted MCs the ability to process and present Ags directly to T cells with preferential expansion of Ag-specific regulatory T cells over naive T cells (Kambayashi et al., 2009). Recent observations show that MCs express various classes of co-stimulatory molecules that significantly modulate MC-function. These molecules might therefore contribute to the outcome of MC-associated pathologies and represent new therapeutic targets in such diseases (Bachelet and Levi-Schaffer, 2007). Among the co-stimulatory molecules we can find TNF family members such as CD40L, OX40L, Fas or TRAIL-R. In particular, CD40L was shown to play a relevant role in the context of the interaction between MCs and B lymphocytes. Several studies have detected CD40L on the surface of MCs even if the expression levels were shown to be different depending on the cell source and on the type of MC-activation (Gauchat et al., 1993; Merluzzi et al., 2010; Pawankar et al., 1997). It has been demonstrated that activated MCs can regulate CD40 surface expression on unstimulated B cells and that the interaction between B cell-expressed CD40 and CD40L on MCs was involved in the B cell differentiation into CD138+ plasma cells and in selective IgA secretion (Merluzzi et al., 2010). Moreover, the CD40L/CD40 axis plays a significant role in MC-driven expansion of IL-10–competent B cells *in vitro* (Mion et al., 2014a).

Depending on the type of stimuli that they receive, MCs secrete different products that can trigger varied and different immune responses (Frossi et al., 2004). MC-derived soluble mediators are reported in table 1.2 and they can be divided into two main categories:

performed mediators, such as histamine, proteoglycans, neutral proteases and cytokines such as TNF- $\alpha$ , or newly synthesized mediators such as cytokines, chemokines, lipid mediators, growth and angiogenic factors (Galli et al., 2005b; Metz and Maurer, 2007).

Class	Mediators	Physiological effects
<b>PREFORMED</b>		
Biogenic amines	Histamine	Vasodilatation
	5-hydroxytryptamine	Leukocyte regulation, pain, vasoconstriction
Proteoglycans	Heparin, heparin sulfate	Angiogenesis, coagulation
	Chondroitin sulfate	Tissue remodeling
Proteases	Trypsin	Inflammation, pain, tissue damage, PAR activation
	Chymase	Inflammation, pain, tissue damage
	MC-CPA/Carboxypeptidase A	Enzyme degradation
	CathepsinB, C, D, E, G, L, S <sup>b</sup>	Pathogen killing, tissue remodeling
	MCP5/6	Pathogenesis of asthma and other allergic disorders
Lysosomal enzymes	$\beta$ -hexosaminidase, $\beta$ -glucuronidase, $\beta$ -galactosidase, arylsulfataseA	ECM remodeling
Others	Nitric oxide synthase	NO production
	Endothelin	Sepsis
	Kinins	Inflammation, pain, vasodilatation
		Anti-inflammatory effects
<b>NEWLY SYNTHESIZED</b>		
Lipid-derived	LTB <sub>4</sub> , LTC <sub>4</sub> , PGD <sub>2</sub> , PAF	Inflammation, leukocyte recruitment, endothelial adhesion, smooth muscle cells contraction, vascular permeability
Cytokines	IL-1 $\alpha^a$ , IL-1 $\beta^a$ , IL-2 <sup>b</sup> , IL-3, IL-4, IL-5, IL-6, IL-8 <sup>a</sup> , IL-9, IL-10, IL-11 <sup>a</sup> , IL-12, IL-13, IL-14 <sup>a</sup> , IL-15 <sup>a</sup> , IL-16, IL-17, IL-18 <sup>a</sup> , IL-22 <sup>b</sup> , IL-25 <sup>b</sup> , IL-33 <sup>b</sup> , MIF, TNF $\alpha$ , IFN $\alpha$ , IFN $\beta^b$ , IFN $\gamma^b$	Inflammation, leukocyte proliferation and activation immunoregulation
Chemokines	CCL1, CCL2, CCL3 <sup>a,b</sup> , CCL4 <sup>a</sup> , CCL5 <sup>a</sup> , CCL7 <sup>a,b</sup> , CCL8 <sup>a</sup> , CCL11 <sup>a</sup> , CCL13 <sup>a</sup> , CCL16 <sup>a</sup> , CCL17, CCL19 <sup>a</sup> , CCL20 <sup>a</sup> , CCL22 <sup>a,b</sup> , CCL25 <sup>b</sup> , CXCL1 <sup>a</sup> , CXCL2, CXCL3 <sup>a</sup> , CXCL4, CXCL5, CXCL8 <sup>a</sup> , CXCL10 <sup>a</sup> , CX3CL	Leukocyte chemotaxis
Growth factors	TGF $\beta$ , SCF <sup>a</sup> , G-CSF, M-CSF, GM-CSF, VEGF, NGF $\beta$ , LIF <sup>a</sup> , bFGF	Growth of various cell types
Antimicrobial species	Antimicrobial peptides, NO, superoxide, ROS	Pathogen killing

Some mediators have been detected only in studies on human <sup>a</sup> or murine <sup>b</sup> MCs or not investigated<sup>a</sup> where not indicated molecules are expressed in both species.  
General references: Galli et al. (2005a), Metz and Maurer (2007).

**Table 1.2. Major MC-derived mediators.** The table show MC soluble products. These mediators can be divided into two categories: preformed and newly synthesized mediators. These products are all important in the regulation of both innate and acquired immunity (Gri et al., 2012).

The rapid release of MC mediators is important for the onset of the immune response at the site of action because they are able to modulate immune-cell trafficking and to provide co-stimulatory signals for cell activation. One of the most important and abundant of these mediators is histamine. Histamine is a vaso-active amine that is stored in MC granules and it binds to specific receptors on several cell types (Caron et al., 2001). Moreover, an important early released MC product is TNF- $\alpha$ . This cytokine derives from the rapid release of preformed stores of the cytokine but can also be synthesized as a newly formed molecule (Gordon and Galli, 1990) and it plays a crucial role in innate immunity (Henz et al., 2001).

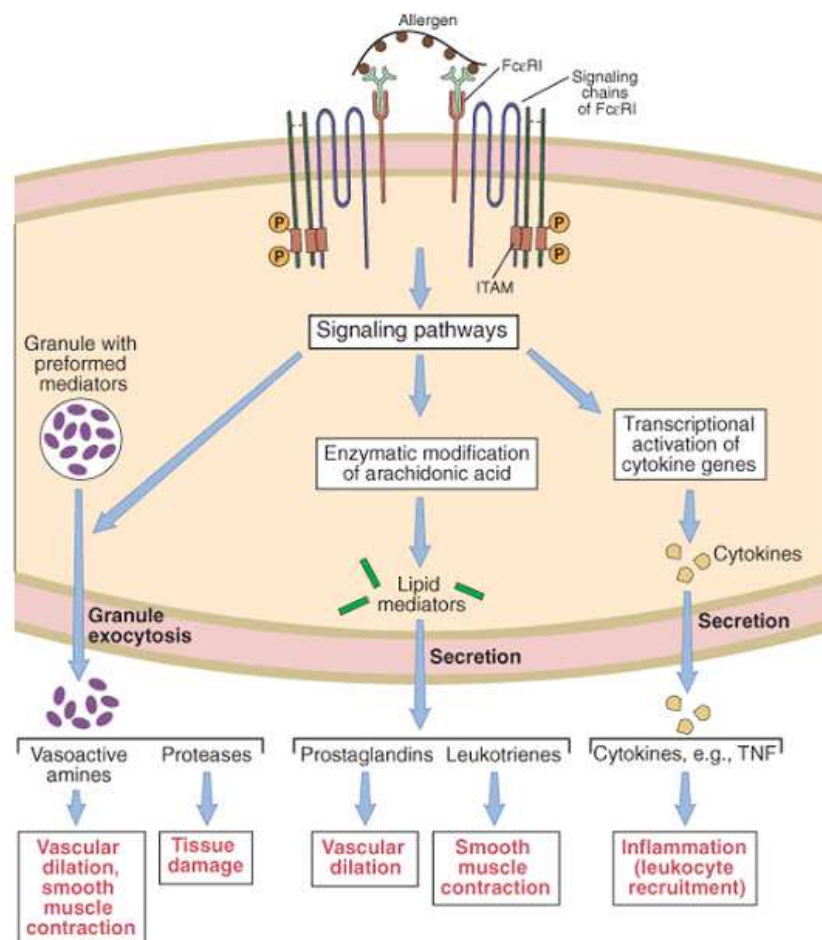


Other pre-synthesized molecules that protect against parasites and venoms are serine proteases, chymase, tryptase and metalloprotease carboxypeptidase A (Metz and Maurer, 2007). Concerning newly synthesized products, MCs can produce arachidonic acid-derived prostaglandins and leukotrienes that improve the innate response by increasing MC number at the inflammatory site, through the recruitment of immature MCs and progenitors (Weller et al., 2005). The compounds secreted by MCs can also contribute to the acquired immune response since they are mediators of the activation and recruitment of B and T cells (Ott et al., 2003).

### **1.1.3. Mast cell activation**

It is now well accepted that MCs are true sensors of the microenvironment: these cells respond to a wide spectrum of immunological and non-immunological signals in a rapid and selective manner. For this reason, these cells are armed with a large repertoire of cell-surface receptors, able to interact directly or indirectly with pathogens (Rao and Brown, 2008). MC activation has been classically distinguished into IgE-dependent and IgE-independent activation. MCs present a multiplicity of G-protein-coupled receptors and other recognition sites on their surface which are involved in MC activation under physiological and pathological conditions. The best characterized mechanism of MC activation is the cross-link of IgE to Fc $\epsilon$ RI on the MC surface by Ag contact (Molderings and Genetics, 2010). The Fc $\epsilon$ RI is a constitutively expressed tetrameric receptor that comprises the IgE-binding  $\alpha$  chain, the membrane-tetraspanning  $\beta$  chain and a disulfide-linked homodimer of the  $\gamma$  chains with high affinity for IgE (Rivera and Olivera, 2008). The interaction of a specific Ag with IgE already bound to Fc $\epsilon$ RI (IgE-prensensitized MC) leads to the aggregation of Fc $\epsilon$ RI. Aggregation of Fc $\epsilon$ RI by polyvalent Ag recognized by bound IgE activates MCs and is the basis for anaphylaxis and other allergic diseases. Fc $\epsilon$ RI density on the surface of MCs is

upregulated in the presence of elevated free IgE levels and in the presence of IL-4, thus enhancing activation (Stone et al., 2010). This interaction initiates a series of biochemical events. The result of these events is MC-degranulation after which there is release of biologically active mediators with immunoregulatory or immunomodulatory effects, including histamine, proteases, arachidonic acid metabolites, cytokines and chemokines. Through the release of these molecules, MCs act a series of events that result in both immediate and late-phase allergic responses. (Siraganian, 2003; Metcalfe et al., 1997). This process is summarized in Fig. 1.5.



**Figure 1.5. MC activation.** Cross linking of IgE on the MC by an allergen stimulates phosphorylation of immunoreceptor tyrosine based activation motifs (ITAM) in the signaling chains of the IgE Fc receptor, which then initiates multiple signaling pathways. These signaling pathways stimulate the release of MC-granule content (Abbas et al., 2012).

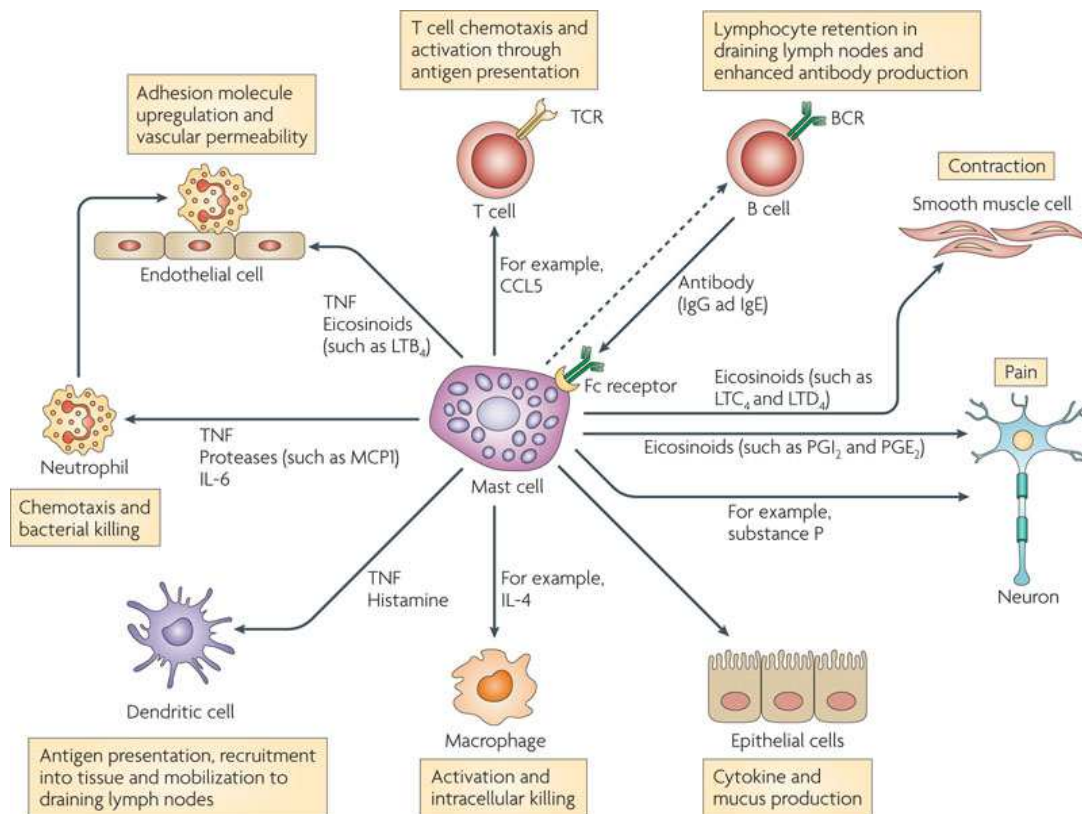
The Ag-driven aggregation of IgE-occupied FcεRI leads to the phosphorylation of immunoreceptor tyrosine based activation motifs (ITAMs) by Lyn kinase and the activation

of Syk kinase through ITAM binding. Then, Fyn kinase is also activated and this activation is important for phosphorylation of Gab2 that is involved in activation of Phosphatidylinositol-4,5-bisphosphate 3-kinase (PI3K) activity. Syk and Lyn phosphorylate several adaptor proteins that regulate MC activation, such as Linker for activation of T cells (LAT) and Non-T cell activation linker (NTAL). LAT regulates the activation of phospholipase C $\gamma$  (PCL- $\gamma$ ) that cleaves phosphatidylinositol-4,5-bisphosphate in two second messengers, that are the inositol-1,4,5-trisphosphate (IP3) and the membrane-bound 1,2-diacylglycerol (DAG). IP3 binds to its receptor on the membrane of the endoplasmatic reticulum and leads to an increase of Ca<sup>2+</sup> in MC cytoplasm. The wave of Ca<sup>2+</sup> is involved in activation of Ca<sup>2+</sup>-dependent kinases and leads to MC degranulation and to activation of NF- $\kappa$ B and other transcriptional factors necessary for the regulation of gene expression (Rivera and Gilfillan, 2006).

Concerning the IgE-independent activation, several stimuli different from IgE/Ag are known to promote MC responses. Indeed, some polybasic molecules, peptides, lectins and dextran derivatives were shown to induce the release of histamine from MCs. (Galli et al., 1999). The list of IgE-independent MC agonists varies between the murine and human system and also among human MCs from different body sites (Bischoff, 2007). This stands particularly true in the case of TLR ligands, Differently from the human counterpart, murine MCs can be easily activated by lipopolysaccharide (LPS) since they express CD14 in addition to TLR4 (Varadaradjalou et al., 2003). Supajatura and coworkers observed quantitative and qualitative differences in the activation of MCs via TLR2 and TLR4 stimulation. TLR2-mediated MC activation by peptidoglycan leads to degranulation and production of IL-4 and IL-5, in contrast to TLR4-mediated MC activation, in which TNF- $\alpha$ , IL-1 $\beta$ , IL-6, and IL-13 are the major cytokines produced (Supajatura et al., 2002).

### 1.1.4. Mast cells: crosstalk with other immune cells

MCs may influence the development, intensity and duration of adaptive immune responses that contribute to host defense, allergy and autoimmunity. MCs interact with several cells among which dendritic cells (DCs), lymphocytes, endothelial cells and fibroblasts and other cells of the immune system (Fig.1.6). Concerning the crosstalk between MCs and DCs, there are both *in vivo* and *in vitro* evidences that MCs have the potential to influence the migration, maturation and function of DCs (Galli and Tsai, 2008; Galli et al., 2005a). Moreover, it has been demonstrated that MC products can influence the maturation of DCs at sites of inflammation (Mazzoni et al., 2006).



**Figure 1.6. MCs can interact with several cell types.** The MC surface molecules and secreted products that can influence various aspects of the biology of DCs, epithelial cells, neutrophils, T cells and/or B cells and others are presented. MC activation with IgE and specific Ag results in the secretion of a diverse range of products. Some of these products can also be released by particular MC populations that have been stimulated through TLRs or through other cell surface receptors that can interact with specific cytokines, products of complement activation or pathogens, endogenous peptides and so on (Abraham and St John, 2010).

Several reports have demonstrated MC ability to modulate T cell function, in different immunological contexts (Galli et al., 2005a). MCs were shown to induce Ag specific CD8<sup>+</sup> T cell activation and proliferation (Orinska et al., 2005), but also to interact with regulatory T cells that can inhibit MC degranulation through cell-cell contact. In particular, it has been found that the interaction of OX40-expressing regulatory T cells with OX40L-expressing MCs inhibited the extent of MC degranulation *in vitro* and the immediate hypersensitivity response *in vivo* (Gri et al., 2008). MCs can interact with natural killer cells (NK), eosinophils, myeloid derived suppressor cells and neutrophils. Activated MCs can induce NK cell accumulation in different disease models. For instance, immune surveillance by MCs is important for NK cell recruitment and viral clearance during Dengue infection (St John et al., 2011). It has been demonstrated that in murine infection peritonitis some MC-derived molecules have a role in the recruitment of neutrophils (Ramos et al., 1991). Although the interaction between MCs and neutrophils has been established, the receptor-ligand pairs that might physically mediate the crosstalk between these two cell populations have not yet been described. Finally, there are preliminary studies that disclose a novel relationship between MCs and myeloid suppressor cells and Treg (Yang et al., 2010b).

### **B/MC interaction**

Concerning the crosstalk with cells of the adaptive immune system, the existence of an interplay between B cells and MCs or basophils has been disclosed by diverse evidences. FcRs on the surface of MCs or basophils represent the most immediate link between these cells (Merluzzi et al., 2014) and the engagement of Fc $\gamma$ R by IgG has been related to different pathologies (Malbec and Daëron, 2007). As already mentioned, MCs produce a broad array of cytokine, such as IL-4, IL-5, IL-6 and IL-13, that are known to regulate, in combination with other factors, B cell development, survival and function. Co-stimulatory molecules are the

factors that support cytokine in this function, and the CD40/CD40L axis plays a particularly relevant role in the B/MC interaction (Pawankar et al., 1997). The crosstalk between these two cell types was first described by Gauchat and coworkers which demonstrated that MCs can interact with B cells to induce the production of IgE, in presence of IL-4 but in absence of T cells. They also shown that Ab class switch recombination (CSR) could occur in peripheral organs such as lung or skin and that MCs could be responsible of this process (Gauchat et al., 1993). The contribution of MCs to Ab class switching is not unique to the IgE, but it occurs also for IgA. In our laboratory, it has been demonstrated that MCs can directly induce the differentiation of activated B cells into IgA-secreting CD138+ plasma cells. Moreover, a concomitant accumulation of MCs and IgA was shown to occur within inflamed tissues in biptic samples of inflammatory bowel disease patients (Merluzzi et al., 2010). This observation reinforces the idea that the B/MC crosstalk may contribute to T-independent IgA response in the intestinal lamina propria and it leads to hypothesize a link between MCs and plasma cells. In addition to cytokines and membrane-bound molecules, B cells and MCs were shown to interact also by means of membrane vesicles called exosomes. The group of Mécheri reported experiments in which MCs lead to B cell activation, blast formation and IgM production without the need of MC-activation and physical contact (Tkaczyk et al., 1996). These evidence led to the identification of exosomes, through which MCs mediate T cell-independent B cell activation (Skokos et al., 2001).

Recently, it was shown that MCs can affect not only the B-cell effector function but also their regulatory properties.. Work published in our laboratory demonstrated that MCs can expand IL-10-competent B cells, but they do not directly induce IL-10 production; moreover, the absence of MCs negatively affects IL-10-competent B cell differentiation *in vivo*. Noteworthy, it has been demonstrated that the CD40L/CD40 axis plays a significant role in MC-driven expansion of IL-10-competent B cells *in vitro* and highlight the importance of MC CD40L signaling in the colon (Mion et al., 2014a).

### **1.1.5. Mast cells and tumors**

As reported by Hanahan and Weinberg, the hallmarks of cancer include ten mechanisms involved in tumor growth (Hanahan and Weinberg, 2011). One of these ten phases of cancer development is the inflammation step which faces the interaction of tumor-infiltrating immune cells with cancer cells and that plays a very important role in tumor progression. Among the tumor-infiltrating cells, MCs have been found to infiltrate the stroma of several tumors (Grivennikov et al., 2010). Although the study of the role of MCs in tumor progression is at the beginning, it is clear that MC-derived mediators can either exert pro-tumorigenic functions, causing progression and spread of the tumor, or anti-tumorigenic functions, limiting tumor growth.

Westphal was the first to suggest, in 1891, a pro-tumorigenic role for MCs after observing an increased number of MCs in diverse tumors, among which breast cancer, lip cancer, squamous cell carcinoma of the oesophagus, melanoma, multiple myeloma (MM) and lung carcinomas (Dabiri et al., 2004; Elpek et al., 2001; Ribatti et al., 2003; Rojas et al., 2005; Tataroğlu et al., 2004). Nowadays, the observation of Westphal is corroborated by several studies reporting increased MC numbers both in hematologic and solid tumors. In certain types of tumors, MCs lead to a poor prognosis; this is the case of human lymphoid neoplasms such as Hodgkin's lymphoma, B-cell non-Hodgkin's lymphoma, primary cutaneous lymphoma and MM, and of solid tumors such as pancreatic cancer, hepatocarcinoma, prostate cancer and melanoma (Nico et al., 2008; Ribatti et al., 2000, 2003). On the other hand, in certain malignancies, MCs were shown to exert anti-tumorigenic effects, for example by supporting cancer rejection (Amini et al., 2007). In summary, what we know is that MCs infiltrate the tumor and that they can either promote or inhibit tumor growth depending on the specific setting. Moreover, MC infiltrates are often associated with tumor invasion and

increased microvessel density. All together, these studies on the role of MCs in the tumor context suggest to further explore these cells as possible diagnostic and therapeutic target of tumors.

## **1.2. B CELLS**

B cells and their Abs are the central elements of humoral immunity and protect, as part of the adaptive immune system, against an almost unlimited variety of pathogens. In the human body, defects in B-cell development, selection and function lead to autoimmunity, malignancy, immunodeficiencies and allergy (Pieper et al., 2013). The B cell exerts three main functions: it presents Ag to T cells and it produces Abs and cytokines. In addition to their essential role in humoral immunity, B cells also mediate and/or regulate many other functions essential for immune homeostasis (Lebien and Tedder, 2008a). These cells have taken the name from the site where they were first discovered, the bursa of Fabricius, a primary lymphoid organ found only in birds and in which the process of B-cell maturation occurs. B cells can be distinguished from other lymphocytes, such as T cells and NK cells, for the presence of a membrane-bound protein known as B-cell receptor (BCR). This transmembrane receptor protein is composed of the CD79a/CD79b heterodimer and of a membrane-bound Ab that leads B cells to bind specific Ags. Once the Ag binds to the BCR on the cell surface, it is internalized by receptor mediated endocytosis, processed and presented through the MHC class II to other cells (Marsh et al., 1992).

As already mentioned, B cells can produce numerous cytokines that can be classified in effector and regulatory cytokines. Effector B cells can amplify humoral and cellular immune responses through the release of interleukin 2 (IL-2), IL-4, IL-6, IL-12, TNF- $\alpha$ , and interferon- $\gamma$  (IFN- $\gamma$ ), whereas the regulatory cytokines are IL-10 and transforming growth

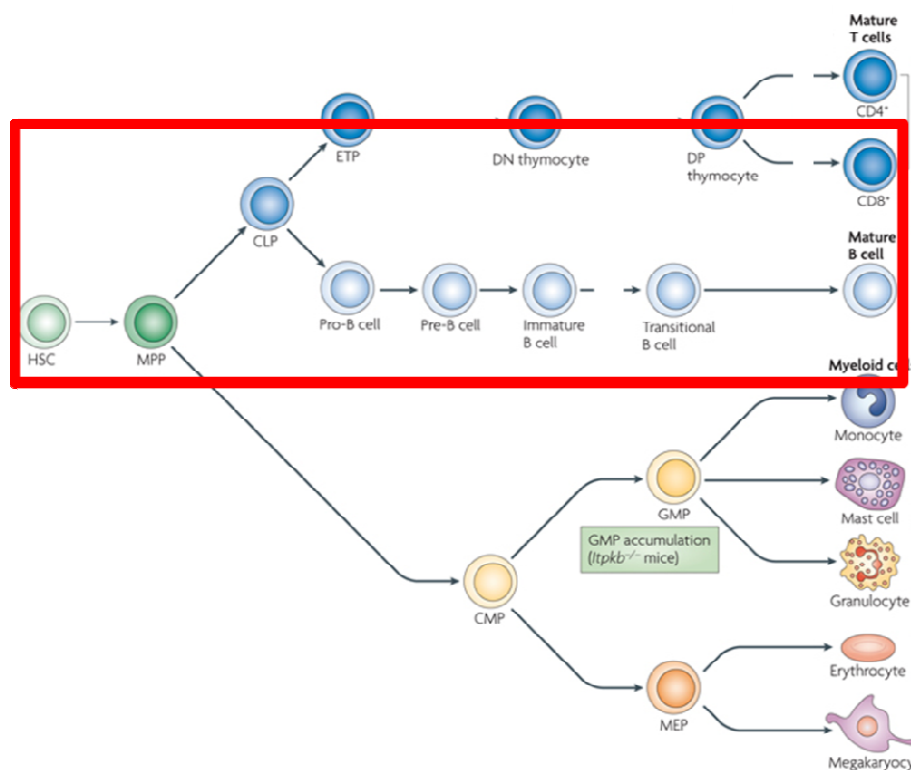


factor-beta (TGF- $\beta$ ) (Lund et al., 2005; Mizoguchi and Bhan, 2006). Interestingly, the production of IL-10 and TGF- $\beta$  by B lymphocytes has led to the identification of a functional B-cell subset with immunosuppressive functions, which regulates the inflammatory response made up by T cells (Lebien and Tedder, 2008b).

### **1.2.1. B-cell development and differentiation**

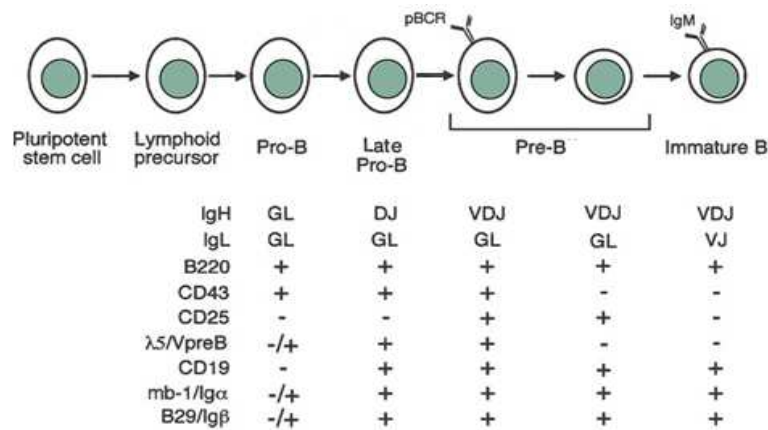
B cells develop from hematopoietic precursor cells in an ordered maturation and selection process. The hematopoietic system continuously regenerates all blood cells, indeed B lymphocytes are made continuously throughout life. This continuous process involves differentiation of the pluripotent HSC to more restricted progenitor cells, which undergo commitment to one of several pathways and then develop into mature cells of the selected lineage. One of the earliest steps in the hematopoietic development is the commitment of Multipotent Progenitors (MPP) to either the lymphoid or erythro-myeloid lineages, resulting in the formation of the Common Lymphoid Progenitors (CLPs) or Common Myeloid Progenitors (CMPs) (Fig.1.7). CLPs progenitors generate T lymphoid cells or B lymphoid cell. CLPs initiate the T cell lineages through early thymic progenitors (ETPs) and B cell lineages through pro-B cells. In this phases there are several factors that lead to either a T or B progeny. B-cell development depends on the transcription factors E2A, EBF and Pax5a. In the bone marrow, pro-B cells develop through pre-B cells into immature B cells. These translocate into the spleen to mature through transitional stages into mature B cells.

(Busslinger, 2004).



**Figure 1.7. Overview of normal human hematopoiesis.** Hematopoiesis originates from HSCs. Multipotent progenitors (MPPs) give rise to common lymphoid progenitors (CLPs) or common myeloid progenitors (CMPs). CLPs initiate the T cell and B cell lineages through early thymic progenitors (ETPs) and pro-B cells, respectively. In the bone marrow, pro-B cells develop through pre-B cells into immature B cells. These translocate into the spleen to mature through transitional stages into mature B cells. Modified from (Sauer and Cooke, 2010).

B cell development occurs through several stages, each of which is characterized by a specific rearrangement of the DNA at the Ab loci. Pre and pro-B cells have low expression of the recombination-activating gene 1 (RAG-1) and RAG-2 genes (Oettinger et al., 1990; Schatz et al., 1989) and they do not express components of the BCR (Li et al., 1993). Pro-B cells are distinguished from earlier precursors by a series of cell surface markers: B220 (CD45), CD43, CD10, CD34 and CD19.



**Figure 1.8 .B cell development from the pro-B to the immature B cell stage.** The stages of B cell development are defined by the rearrangement status of the IgH and IgL chains. The expression of surface markers characterizing the different maturative stages are also indicated. Adapted from (Maier and Hagman, 2002).

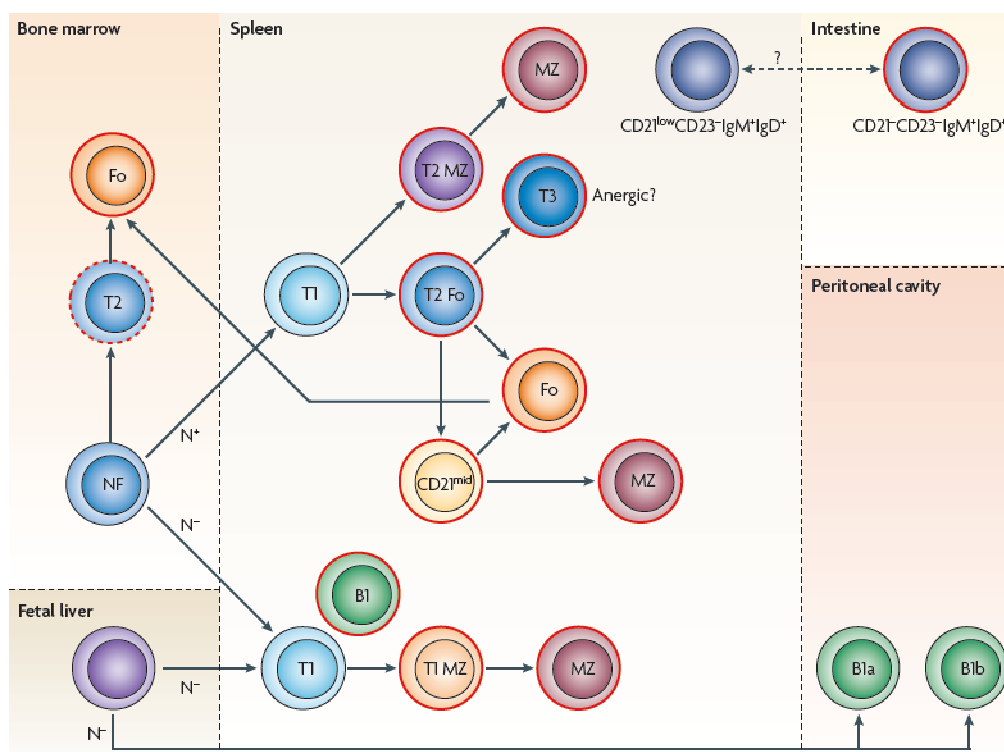
As progenitors progress through the pro-B stage, they express Terminal deoxinucleotide Transferase (TdT), RAG-1 and RAG-2 and, V(D)J recombination is initiated (Hardy et al., 1991). Ig gene recombination begins with diversity (D) to junction ( $J_H$ ) segment rearrangement; then, in the late pro-B stage,  $V_H$  (variable) genes become accessible to the V(D)J recombinase and complete heavy chain transcription units are assembled (Alt et al., 1984). Expression of membrane-bound  $Ig\mu$  (mIg $\mu$ ) results in assembly of the pre-BCR and marks the transition to the pre-B cell stage. The pre-BCR is composed of mIg $\mu$  and surrogate light chains ( $\psi L$ , V-pre-B and  $\lambda 5$ ) and is a key checkpoint regulator in B-cell development (Karasuyama et al., 1990; Tsubata and Reth, 1990). Its primary functions are to trigger B cell differentiation, clonal expansion and heavy chain allelic exclusion. Indeed, the deletion of components of the pre-BCR blocks B cell development at the pro-B cell stage and lymphocytes are eliminated (Gong and Nussenzweig, 1996). After clonal expansion of mIg $\mu$  producers, pre-B cells arrest in G1. RAG and Ig $\kappa$  germline transcripts are expressed and pre-B cells undergo IgL chain gene recombination (Maki et al., 2000). Successful IgL chain gene rearrangement leads to BCR assembly and replacement of the  $\Psi L$ s in the pre-BCR by Ig $\kappa$  or Ig $\lambda$ . Ig gene rearrangement can continue even after the assembly of functional BCRs. Apart from the expression of the pre-BCR receptor complex, the pre-B cell stage is

characterized, by a decrease in the expression of CD43, lack of TdT expression, and the successful rearrangement of the IgH locus. As these pre-B cells proceed through the differentiation process, the RAG genes are induced and IgL chain rearrangements begins (Henderson and Calame, 1998). Pre-B cells can be generally subdivided into large proliferating cells designated pre-BI (or large pre-B cells) and small postmitotic cells designated pre-BII (or small pre-B cells) on the basis of cell cycle analysis (LeBien, 2000). The completion of Ag-independent B cell development is marked by successful rearrangement of the IgL chain genes and expression of surface IgM. The cells then exit the bone marrow and migrate to the periphery.

### **1.2.2. Maturation and activation of B cells**

When B cells leave the bone marrow they are still in an immature form; these cells have short life, high levels of IgM and low levels of IgD. The levels of IgM increase in *naïve* B cells and these cells enter in peripheral lymphoid tissues when they receive the required signals for their survival (Thomas et al., 2006). Immature cells that survive to negative selection and migrate from the bone marrow to the periphery (initially to the splenic red pulp) are referred to as transitional B cells and they can be distinguished from mature B cells by several cell surface markers (Yu et al., 1999). In the spleen, transitional B cells receive signals that lead to their progression to Ab secreting cells. Specifically, in order to develop from the immature state in the bone marrow to the mature *naïve* state in peripheral lymphoid organs, a B cell must survive three checkpoints. The first checkpoint is between the immature cell and the transitional type 1 (T1) cell in the spleen. The second is between the T1 and the more mature T2/3 state, and the third is between the T2/ T3 stage and mature B cells. The nature of the BCR determines whether a B lymphocyte will become either a follicular (FO) or a marginal zone (MZ) B cell, a decision that is taken at the T2 stage (Pillai et al., 2005)(Pillai et al.,

2005). Negative selection at each of these checkpoints is mediated by BCR signaling and is generally considered to be a B cell intrinsic property (Jacobi and Diamond, 2005). It has been demonstrated that a fundamental role in this process is also performed by BAFF (Fig. 1.9). *In vitro* studies found that treating mice with BAFF increased the number of splenic cells, in particular transitional B cells (Hsu et al., 2002; Moore, 1999). The effect of BAFF on B cell survival and longevity was limited to late transitional and mature B cells. Interestingly, the interaction of BAFF with its specific receptor BAFF-R is essential for survival of B cells in the transition from the T1 stage to the one of B2 cells, while only a minor contribution is given by the binding to TACI or B cell maturation antigen (BCMA) (Mackay et al., 2003).



**Figura 1.9. BAFF-dependent maturation of murine B cells.** B cell subsets circled in red require BAFF for development and survival.

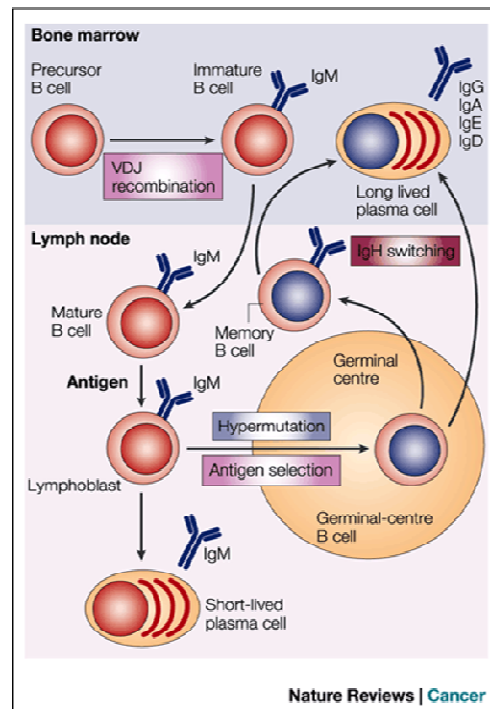
A role of BAFF and BAFF-R in the survival of B cells during B cell maturation was shown in BAFF- and BAFF-R- deficient mice, in which the maturation of MZ and B2 cells is impaired

beyond T1 stage (Pillai et al., 2005). Moreover, the production of BAFF and APRIL by non-haematopoietic cells of local niches was shown to modulate the survival and function of B cells and plasma cells in health and disease.

After B cell maturation, lymphocytes can bind the Ag and this leads to B cell activation. Activation of B cells can occur in a T-dependent manner, in which T cells have a central role, or in a T-independent manner in which other cells of the immune system mimic the role of T cells. T-independent activation occurs when B cells bind to thymus-independent (TI) Ags, which are divided in two categories, on the basis of their ability to stimulate an immunodeficient strain of mice, CBA/N, to produce Abs (Mond et al., 1978). T-independent type 1 (TI-1) Ags activate B cells without the need of a second signal, either in a polyclonal (prototype LPS) or an Ag-specific fashion (several viruses among which the vesicular stomatitis virus (Bachmann et al., 1995; Fehr et al., 1996). In contrast, T-independent type 2 (TI-2) Ags need residual non-cognate T help for activation of B cells (polymeric Ags as dextran or bacterial polysaccharides (Mond et al., 1995)). TI-2 Ags have high molecular weight and they are characterized by highly repetitive structures. They are able to activate only mature B cells with the ability to aggregate the Ag receptor on the cell membrane. In particular, it has been demonstrated that TI-2 Ags affect a particular subpopulation of B cells called B1 (Murphy et al., 2009). Thymus-dependent (TD) Ags induce secondary immune responses characterized by IgG production due to specific T cell help. The interaction between B cells and T cells occurs in lymphoid organs: the Ag is recognized by the B cell via the BCR and then it is engulfed, processed and exposed on the surface of the cell thanks to MHC-II. In this manner, the peptide is recognized by T cells. This binding leads to B cell activation and to the secretion of several cytokines from the T helper (Th) cell. The cognate activated T cell delivers important signals to the B cell through membrane-bound molecules. One of the most important interactions among co-stimulatory molecules is constituted by the CD40-CD40L axis which mediates specific T-cell help in response to TD Ags (Murphy et al.,

2009). The importance of the CD40:CD40L axis is evident in the hypergammaglobulinemia X-linked hyper-IgM syndrome (HIGM) in which the CD40 gene is mutated. Indeed, these patients present defects in isotype switching and in the differentiation to plasma cells (Kawabe et al., 1994).

In conclusion, in the development and maturation of B cells, the functional and protective end point is Ab production by terminally differentiated plasma cells. Ag-induced B cell activation and differentiation in secondary lymphoid tissues are mediated by dynamic changes in gene expression that give rise to the germinal center (GC) reaction (Fig. 1.10) (Lebien and Tedder, 2008a). After the stimulation of B cells, which usually occurs in the GC of secondary lymphoid organs such as the spleen and lymph nodes, activated B cells begin to differentiate into more specialized cells. GC B cells may differentiate into memory B cells or plasma cells. The mechanism by which a B cell becomes one or the other of these is a process known as affinity maturation. Most of these B cells will become plasmablasts, and eventually plasma cells, and will begin to produce large amounts of Abs (Alberts et al., 2008). The GC is a site, within secondary lymphoid organs, where, during a normal immune response to an infection, mature B lymphocytes proliferate, differentiate, mutate their Ab genes (through somatic hypermutation, (SHM), of VH genes) and switch the class of their Abs through CSR. The GC develops dynamically after the activation of FO B cells by TD Ags (MacLennan, 1994).



**Figura 1.10. Plasma cell differentiation.** The binding of the Ag by B cells leads to B cell proliferation and differentiation. Upon stimulation by a T cell, which usually occurs GC of secondary lymphoid organs like the spleen and lymph nodes, the activated B cell begins to differentiate into more specialized cells. GC B cells may differentiate into memory B cells or plasma cells (Kuehl and Bergsagel, 2002).

FO B cells are considered to be classical B-2 cells which respond to TD Ags, undergo GC reactions, and give rise to memory cells. MZ cells, which may also develop from FO B cells, are long-lived and have a partially activated phenotype. They have some features in common with B-1 cells in that they respond primarily to TI Ags and probably do not give rise to memory cells (Wang and Clark, 2003).

### 1.2.3. B cells: class switch and somatic hypermutation

Processes that diversify Abs play a major role in protecting higher organisms from pathogens. Upon encountering the Ag, Ab-expressing B cells adapt to produce a highly specific and potent Ab response (Hauser et al., 2008). Following Ag stimulation, naïve IgM+IgD+ B cells can undergo CSR to express and produce IgG, IgA or IgE (Tangye et al., 2006). After V(D)J



recombination, that, as explained above (see paragraph 1.2.1), in mammalian occurs in the bone marrow during early development, immature B cells move into peripheral lymphoid organs and Ag-activated B cells go through secondary Ab diversification by two DNA modification processes, CSR and SHM. CSR takes place in IgH switch (S) regions located upstream of the constant (C) region genes, while SHM occurs in variable (V) region genes (Chaudhuri and Alt, 2004; Di Noia and Neuberger, 2007). Both these two processes require a 24 kDa enzyme called activation-induced cytidine deaminase (AID), that generates mutations in the DNA (Peled et al., 2008; Stavnezer et al., 2008). Specifically, this enzyme can induce two major alterations in Ig gene loci to enhance Ab and B cell function. First, the process of SHM introduces single point mutations at variables genes, increasing Ab affinity for the Ag (Longerich et al., 2006). Secondly, CSR replaces the Ig heavy chain constant region C $\mu$  for C $\gamma$ , C $\epsilon$  or C $\alpha$  and thereby controls the Ab effector function (Honjo et al., 2002). Initially, AID expression was thought to be limited to FO B cells of the GC (Muramatsu et al., 1999), but further studies have demonstrated that AID is active also outside the GC microenvironment (Mao et al., 2004). In mice, AID is induced by the CD40L:CD40 axis between T and B cells or by the binding of TLR4 by LPS (Nagaoka et al., 2010). These stimuli increase AID expression mainly through NF- $\kappa$ B signaling (Xu et al., 2012). Several studies have demonstrated that cytokines produced by macrophages or DCs, such as TGF- $\beta$ , IL-4, BAFF and APRIL, increase AID expression (Kim et al., 2007). The expression of AID is finely regulated under physiological conditions (Park, 2012) and this means that its aberrant expression can lead to the onset of tumors for genetic instability due to chromosomal translocations and point mutations. Because AID is responsible for both CSR and SHM, it may promote the development of autoimmune diseases by allowing the production of mutated autoreactive IgG B cells and autoreactive high affinity Abs (Durandy et al., 2013). Indeed, AID-deficiency in MRL/lpr mice abrogates lupus nephritis and a decrease in AID expression delays the development of such pathology (Jiang et al., 2007). It has been shown that

constitutive and ubiquitous expression of AID in transgenic mice caused both T cell lymphomas and dysgenetic lesions of epithelium of respiratory bronchioles (micro-adenomas) in all individual mice. Moreover, ectopic expression of AID could be partly responsible of malignancy in mice as well as in humans (Okazaki et al., 2003). Conversely, enzyme deficiencies are related to immunodeficiencies with loss of diversity of Igs (Quartier et al., 2004). Several other pathologies can be exacerbated from AID aberrant expression: for example, in MM, this enzyme could play a very important role since a work from Bergsagel group underlined the possible correlation between ectopic AID expression and this pathology (Chesi et al., 2008).

#### **1.2.4. B cell populations**

B cells can be divided into different populations that are characterized by the differential expression of intracellular and cell surface markers. Among murine B cells, two distinct lineages, B-1 and B-2, can be identified. These cells have different developmental origin, anatomical localization and functional characteristics (Hardy and Hayakawa, 2001). In particular, B-1 cells are mainly located in body cavities (such as the peritoneal cavity) and, in a lower frequency, in the spleen. Conversely, B-2 cells are generally found in spleen and lymph nodes. B-1 cells can be divided into two population: B-1a cells, that are CD5<sup>+</sup>, and B-1b cells that are CD5<sup>-</sup>. B-1a cells produce Abs against bacterial components while B-1b cells produce low affinity Abs in response to TI-2 Ags (Lebien and Tedder, 2008b). Among B-2 cell we can find FO and MZ B cells. FO B cells circulate in the periphery and are able to produce high affinity Abs while MZ B cells constitute a non-circulating population that responds to immunogenic stimuli in TI manner. MZ B cells are a first line of defense against circulating Ags in the blood, they produce a limited repertoire of Abs but in a rapid manner.

For this reason MZ B cells and B-1 lymphocytes are defined “innate type lymphocytes” (Cerutti et al., 2013).

Another B cell population that is important to mention is constituted by regulatory B cells (Bregs), which participate in immunomodulation and in suppression of immune responses (Lebien and Tedder, 2008a). These cells have elicited great interest in recent years, nevertheless the mechanisms regulating their induction and differentiation are still not clear. There are several mechanisms through which Bregs can exert their action and the production of IL-10 is certainly one of the most studied (Balkwill et al., 2013). IL-10 has strong anti-inflammatory effects (Asseman et al., 1999) and it inhibits or suppresses inflammatory reactions mediated by T cells, especially Th1 type immune reactions. It is now clear that Bregs contribute to preserve immune homeostasis and they do so by modulating effector responses, both in contact-dependent and -independent manner. Indeed, the presence of different subsets of Breg cells, potentially distinct for their ontogenesis as well as for the differentiation and activation pathways, makes intriguing the study of these cells and gives to the immunologist the opportunity to investigate the development and regulation of immune system (DiLillo et al., 2010). On a more applicative perspective, the study of Breg cells could lead to the development of novel therapeutic approaches and to the understanding of the mechanism of action of biological drugs in inflammatory and autoimmune disease and cancer (Vitale et al., 2010).

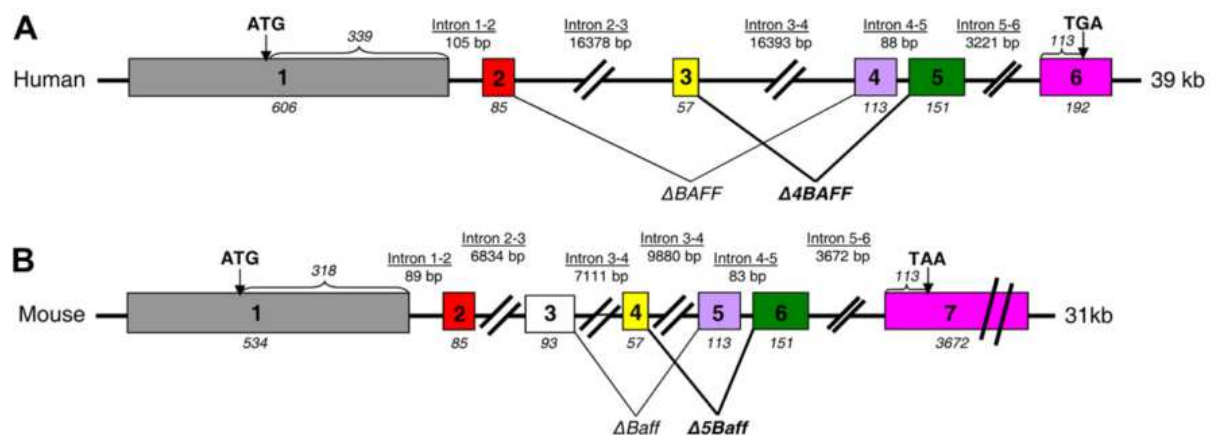
### **1.3. BAFF: B-CELL ACTIVATING FACTOR**

The immune system is a machinery of biological structures and processes that protects against disease. The different and several cell types composing the immune system orchestrate the immune response, fundamental for human life. In the immune system, the balance between cell survival and death is the basis of the controlled cell expansion in response to pathogens

and also in tissue homeostasis. When appropriate growth and survival signals are missing, most cells die. The control of cell survival is believed to involve the regulation of the anti-apoptotic machinery (Plas et al., 2002). The elements that affect lymphocyte survival have been the focus of much attention in recent years. There are several cytokines that play a role in lymphocyte's survival, one of this is BAFF.

BAFF was identified for the first time in the late 1990s in a human neutrophil/monocyte-derived complementary DNA library (Kalled, 2006; Mackay and Browning, 2002). Its discovery heralded a new understanding of B cell tolerance and differentiation and, consequently, of autoimmune diseases. Indeed, the blockade of BAFF constitutes a new therapeutic approach for the treatment of various pathologies, such as different autoimmune diseases (Sjögren's Syndrome, SjS or Systemic Lupus Erythematosus, SLE) and some type of tumors (Mackay and Tangye, 2004; Moisini and Davidson, 2009).

The gene encoding for BAFF is located on human chromosome 13q33.3 and contains 6 exons and 5 introns corresponding to 39 kb (Fig. 1.11 A). Instead, in the murine system, the gene of BAFF is mapped on chromosome 8 A1.1 and contains 7 exons and 6 introns corresponding to 31 kb (Fig. 1.11 B) (Lahiri et al., 2012; Moore, 1999; Schneider et al., 1999).



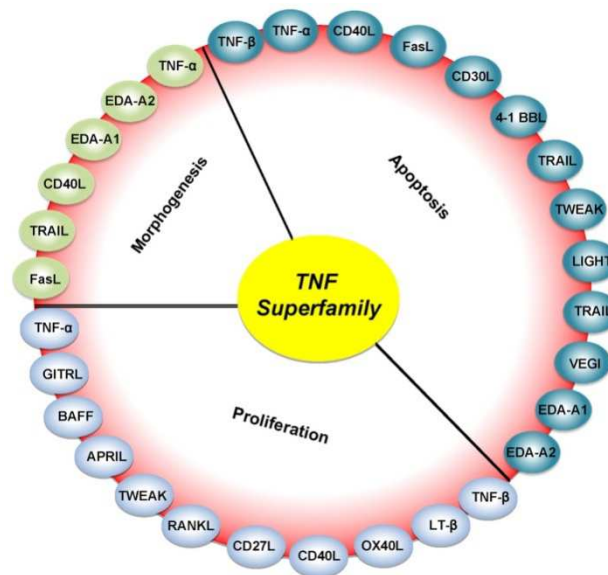
**Figure 1.11. BAFF gene structure.** A. Structure of the human gene of BAFF, constituted by 6 exons and 7 introns. B. Structure of the murine gene, constituted by 7 exons and 6 introns (Lahiri et al., 2012).

This cytokine is also known as B lymphocyte stimulator (BLys) protein, TNF and apoptosis ligand-related leukocyte-expressed ligand-1 (TALL-1), zTNF4, CD257, TNFSF13B, TNF superfamily member (TNFS20) and TNF homolog that activates apoptosis, NF- $\kappa$ B and c-Jun NH2-terminal kinase (THANK) (Daridon et al., 2008; Lesley et al., 2004). Although initially believed to be produced solely by cells of the myeloid lineage, BAFF can be expressed also by cells of non-hematopoietic origin (Nardelli et al., 2001a). To date, it is known that BAFF is produced by monocytes, macrophages, neutrophils, DCs, activated T cells, FO DCs, splenic radiation-resistant stromal cells, astrocytes, fibroblast-like synoviocytes, nurse like cells osteoclasts and ductal epithelial cells (Kalled, 2006). In macrophages, BAFF represents the factor that more than others exerts a critical role on B cell biology (Craxton et al., 2003). It has been shown that, in the macrophage-like cell line RAW 264.7, its expression is increased after stimulation with TGF- $\beta$ 1 (Kim et al., 2008), and this is a critical event since TGF- $\beta$ 1 also act as a powerful switching factor for IgA and IgG2b isotype switch (McIntyre et al., 1993).

### **1.3.1. BAFF structure**

BAFF is a member of the TNF family and it is composed of 285 amino acids (31,2 kDa) in humans and 309 amino acids (34,2 kDa) in mice. This cytokine is the natural ligand of three TNF receptors which are B cell maturation Ag (BCMA), transmembrane activator and CAML interactor (TACI) and BAFF receptor (BAFF-R) (Gross et al., 2000; Marsters et al., 2000). BAFF exerts several functions proper to the TNF-related cytokines, which are known to mediate host defense and immune regulation (Schneider et al., 1999). Indeed, TNF family members are defined as master switches in the immune system, controlling both cell survival and differentiation (Chicheportiche et al., 1997). In recent years, the TNF family has grown dramatically, to encompass at least 11 different signaling pathways that are involved in the regulation of the immune system (Kooten and Banchereau, 1997). This family is composed of

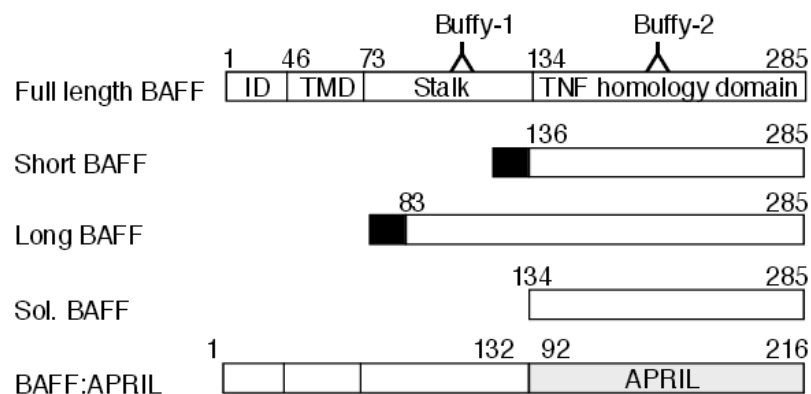
19 ligands and 29 receptors (Fig. 1.12), each of which plays a different role in the human body: proliferative activity, regulation of morphogenesis and control of apoptosis (Aggarwal et al., 2012).



**Figure 1.12. Members of the TNF family.** Without exceptions, all members of the TNF superfamily exhibit pro-inflammatory activity, in part through activation of NF- $\kappa$ B. Some of these molecules (OX40L, CD40L, CD27L, APRIL and BAFF) exert proliferative activity; EDA-A1, EDA-A2, TNF- $\alpha$ , FasL and TRAIL regulate morphogenesis, while TNF- $\alpha$ , TNF- $\beta$ , FasL and TRAIL control apoptosis (Aggarwal et al., 2012).

The members of this family exist in membrane-anchored forms, acting locally through cell-to-cell contact, or as secreted proteins capable of diffusing to more distant targets (Vassalli, 1992). Most TNF ligands are type II transmembrane proteins with extracellular domains that can be cleaved to generate soluble cytokines. These proteins are characterized by a short N-terminal stretch most often constituted by short hydrophilic amino acids. This part is followed by a transmembrane region and an extracellular portion of variable length, that separates the C-terminal receptor binding domain from the membrane (Gruss and Dower, 1995). This particular extracellular region, that is proximal to the transmembrane part, is sometimes called the “stalk” (Richter et al., 2012). Figure 1.13 clearly shows the different domains that constitute BAFF protein: intracellular domain, transmembrane, stalk and extracellular

domain.



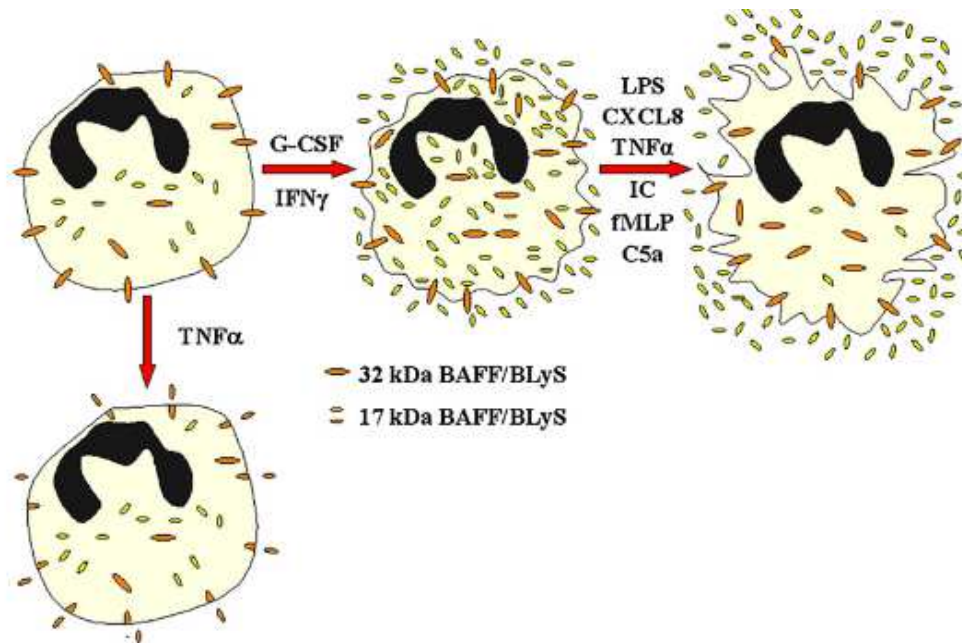
**Figure 1.13. Structure of BAFF.** The intracellular domain is composed by 46 amino acids and it is followed by the transmembrane domain and by the stalk domain. Finally there is the TNF domain, that represents the extracellular part of BAFF (Schneider and Huard, 2010).

BAFF shares roughly 20 to 30% similarity with other 16 members of the TNF family, namely TNF, LT $\alpha$ , LT $\beta$ , LIGHT, FasL, TRAIL, RANKL/ODF/TRANCE, TL1A/VEGI, GITRL/AITRL, EDA, TWEAK, CD40L, CD27L/CD70, CD30L,4-1BBL and OX40L and up to 50% similarity with A Proliferation-Inducing Ligand (APRIL), a ligand that has several biological activities in common with BAFF (Bodmer et al., 2002).

BAFF displays typical features of type II transmembrane proteins, that can be cleaved by an enzyme belonging to the furin family of proteases (Nardelli, 2001; Schneider et al., 1999). Furin is a calcium dependent serine endoprotease that processes numerous proteins of different secretory pathways into their mature forms by cleaving at the carboxyl side of the recognized sequence. It has been shown that this endoprotease is mainly localized in the trans-Golgi network, although a part of the furin molecules cycle between this compartment and the cell surface (Nakayama, 1997). The furin cleavage sites are located on the N-terminal side of the TNF homology domain and permit the release of the soluble form of BAFF (Kanakaraj et al., 2001; Moore, 1999; Schneider et al., 1999). Therefore, BAFF can be found either in the 31-32 kDa membrane form (mBAFF) or in the 17 kDa cleaved or soluble form (sBAFF). The process of BAFF cleavage is very complex: several studies report that furin

cleaves the membrane-bound form of BAFF on cell surface and, in this way, the soluble molecule can be released. This mechanism of BAFF secretion was unequivocally demonstrated using a BAFF-transgenic mouse in which the full-length form was over-expressed specifically in the liver. Soluble BAFF was detected in the blood and B cell hyperplasia was globally observed, indicating the transfer of soluble BAFF from the liver into organs in which the transgene was not expressed (Mackay et al., 1999). In general, cytokines of the TNF superfamily are functional both in their membrane-bound and in the soluble form (Bodmer et al., 2002). Cells expressing a non-cleavable membrane-bound form of BAFF, generated through an insertion mutation at the site of furin cleavage, were at least 50-fold more active than the soluble form of BAFF (Bossen et al., 2008). An alternative direct secretion pathway for BAFF has been described in neutrophils. In 2003, Scapini and coworkers showed that resting human neutrophils contain intracellularly both the unprocessed 32 kDa mBAFF as well as the cleaved 17 kDa sBAFF. The exposure of neutrophils to cytokines such as G-CSF or IFN- $\gamma$  leads to an increased accumulation of BAFF at intracellular level, but it is the subsequent exposure to stimuli such as LPS or TNF- $\alpha$  that induces a remarkable secretion of sBAFF. In an alternative way, the exposure to TNF- $\alpha$  induces the cleavage of mBAFF that generates extracellular sBAFF (Fig. 1.14) (Scapini et al., 2008a). All together, these considerations have led to the conclusion that the process of BAFF production and release is strictly cell- and stimulus-dependent.

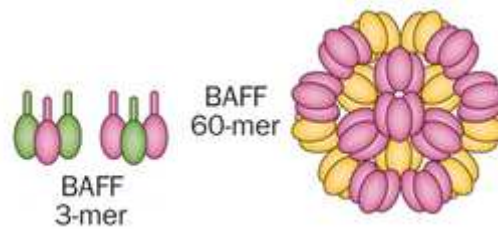




**Figure 1.14. Regulatory mechanisms controlling sBAFF release in human neutrophils.** The figure shows that in neutrophils both the unprocessed 32 kDa and the 17 kDa forms of BAFF are present. After exposure to G-CSF or IFN- $\gamma$  there is an increase of novel synthesized BAFF and a partial release. A remarkable secretion of BAFF occurs when neutrophils stimulated with G-CSF or IFN- $\gamma$  are exposed to pro-inflammatory mediators such as TNF $\alpha$  or LPS. Instead, in resting neutrophils, the exposure to TNF $\alpha$  induces the cleavage of membrane-bound BAFF that generates soluble BAFF (Scapini et al., 2008b).

The members of the TNF family usually assemble as trimers (Bodmer et al., 2002). BAFF was crystallized both as a trimer (BAFF 3-mer) and as a virus-like structure (BAFF 60-mer) (Fig.1.15). This virus-like structure is the result of the ordered assembly of 20 trimers (Karpusas et al., 2002; Liu et al., 2002). A work published in 2008 by Bossen and collaborators explained the different affinity of trimers and virus-like structures of BAFF to their receptors. They demonstrated that, in primary B cells, all forms of BAFF bind BAFF-R and TACI, eliciting BAFF-R dependent signals. In contrast, in plasmablasts or in mature B cells, the signaling through TACI was only achieved by higher disposal of BAFF oligomers. These data indicate that, despite BAFF-R and TACI can supply B cells with similar signals, only BAFF-R can respond to soluble BAFF 3-mer, that is the principal form found in circulation (Bossen et al., 2008). The unusual 60 mer form of BAFF is peculiar of this protein. Some experiments showed that the pH can affect the formation of BAFF trimers and aggregates. At pH equal to six, BAFF is found in its trimeric form, at pH equal to 6,5 the

oligomeric form begins to be detected, while at pH equal to 7,4 only the oligomeric form is present (Lahiri et al., 2012). It has been demonstrated that BAFF 60-mer was moderately more potent than the 3-mer form and, again, that the two different forms of this cytokine bind with different specificity to their receptors (Cachero et al., 2006).



**Figure 1.15. BAFF trimers and virus-like structure.** The figure shows the two different structures of BAFF: BAFF 3-mer and 60-mer (Modified by Vincent et al., 2014).

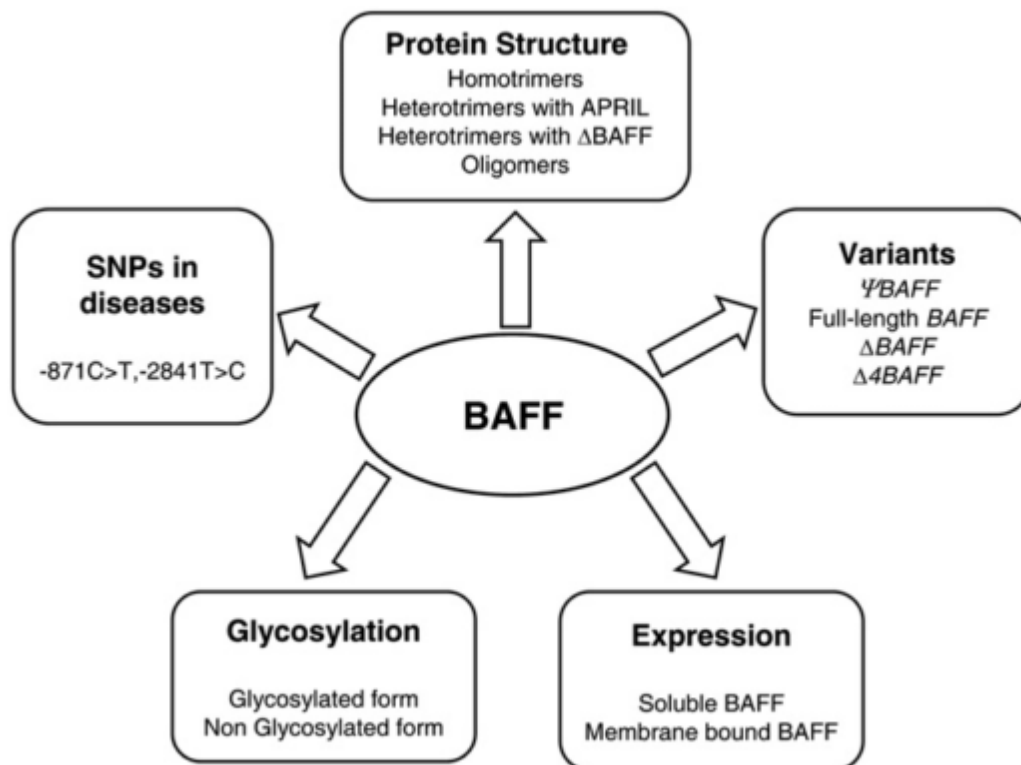
Similarly to most ligands of the TNF superfamily, BAFF is known to be a homotrimer. However, the possibility that BAFF could aggregate also with APRIL in a heterotrimeric form was suggested by structure analysis (Wallweber et al., 2004) and confirmed by the detection of BAFF/APRIL heterotrimers in the serum of patients with rheumatic disease (Roschke et al., 2002). Although these heterotrimers could bind all BAFF receptors, their specific functions are still unknown (Daridon et al., 2008).

### 1.3.2. BAFF variants

In addition to monomers, trimers and oligomers, BAFF can be found in various other forms and this renders even more intriguing the study of this cytokine (Lahiri et al., 2012). The complexity of the “BAFF world” is summarized in Fig. 1.16. At the genetic level, some BAFF polymorphisms (SNPs) have been observed and associated with various diseases. Concerning human BAFF, a polymorphism screening led to the identification of four of this in the promoter, one in intron 1 and a rare one in the coding region (Kawasaki et al., 2002).

Moreover, splicing variants of BAFF have been described.  $\Psi$  BAFF has been reported only in the human system and is the result of the incomplete splicing of intron sequences that leads to a non-functional transcript due to the appearance of a premature stop codon (Gavin et al., 2003). Identified in 2003,  $\Delta$ BAFF is an alternative splice isoform that lacks exon 3 in humans and exon 4 in mice. Some studies reveal that  $\Delta$ BAFF suppresses BAFF function by competitive co-association, limiting BAFF homotrimerization. Moreover, it has been demonstrated that  $\Delta$ BAFF and BAFF have opposing effects on B cell survival (Gavin et al., 2005). Recently the discovery of a new transcriptional variant of BAFF has been reported: in humans we have  $\Delta$ 4BAFF and in mice  $\Delta$ 5BAFF, presenting the excision respectively of exon 4 and 5. These splice variants can directly or indirectly regulate the differential expression of a large number of genes involved in the innate immune response and in the regulation of apoptosis (Lahiri et al., 2012).

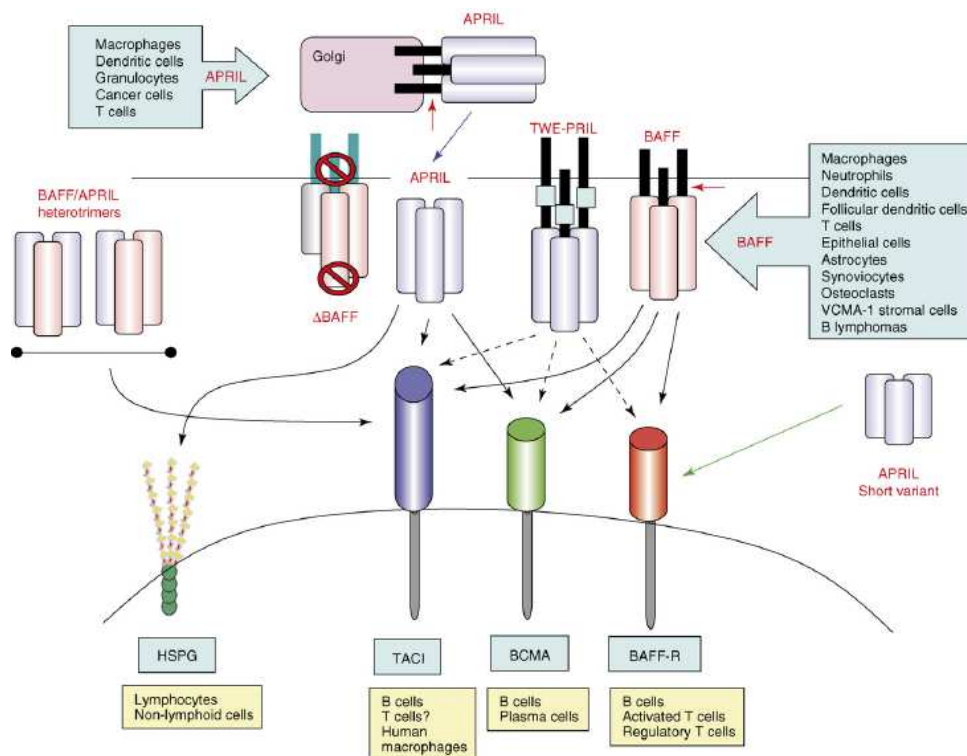
Finally, it is also important to mention that BAFF can present post-translational modifications, although these modifications have not been extensively studied. The only one described is the N-glycosylation: two sites for N-glycosylation are present in BAFF and are constituted by the asparagines at position 124 and 242 (Schneider et al., 1999).



**Figure 1.16. Complexity of the “BAFF world”.** BAFF can exist as oligomer, homotrimer and heterotrimer and also in a soluble or membrane-bound form. The existence of single nucleotide polymorphisms, glycosylation variants and isoforms renders extremely varied the world of BAFF (Lahiri et al., 2012).

### 1.3.3. BAFF receptors

As mentioned above, BAFF can bind to three receptors: BCMA, TACI and BAFF-R (Figure 1.17). The three receptors have differing binding affinities for BAFF; moreover, TACI and BCMA also recognize APRIL, whereas BAFF-R is BAFF specific (Thompson et al., 2001). These receptors are expressed mainly on mature B lymphocytes and their expression varies depending on the specific B cell subset in analysis: while BAFF-R and TACI are expressed among transitional, FO and MZ B cells, BCMA is mainly present on long lived plasma cells (Cancro, 2006). The combination of the differential binding affinity and expression levels of these three receptors has the effect of making even more diverse the function of BAFF in relation to B cell biology.



**Figure 1.17. Receptors of BAFF.** The figure shows the three receptors that can bind BAFF and APRIL (Mackay et al., 2007a).

## TACI

TACI can be found on different subsets of T cells and B cells, especially on activated B cells (Bülow and Bram, 1997). In mice it is expressed by all peripheral B cells and in particular on MZ and B-1 B cells while in humans it is expressed by all CD27<sup>+</sup> memory B cells and by tonsillar and bone marrow plasma cells. This receptor plays critical roles in promoting B cell survival at distinct stages of development by engaging APRIL and/or BAFF. TACI controls T cell-independent B cell Ab responses, isotype switching and B cell homeostasis (Mackay and Browning, 2002; Mackay et al., 2003, 2007a, 2007b). TACI is an unusual TNF receptor-like molecule with a complicated mode of action. Experiments performed with TACI<sup>-/-</sup> mice revealed two apparently controversial roles of this receptor, a positive one driving T cell-independent immune responses and a negative one down-regulating B cell activation and expansion (Mackay and Schneider, 2010). How TACI negatively regulates B cells remains

elusive and this makes even more complicated the understanding of BAFF signaling. However, an important role of TACI is to enhance plasma cell differentiation in cooperation with CD40 binding (Mantchev et al., 2007) and probably to control the activation and survival of plasmablasts derived from innate B cells and thus TI-2 humoral responses (Mackay and Schneider, 2010).

### **BCMA**

BCMA is expressed on plasma cells, plasmablasts and tonsillar GC B cells (Laabi et al., 1994). The function of this receptor is mainly limited to the survival of plasma cells residing in the bone marrow. However, among the three BAFF receptors, BCMA is the one whose role is more confusing. Although BAFF and APRIL can clearly bind to BCMA, (Thompson et al., 2000) studies on BCMA<sup>-/-</sup> mice have shown that this receptor appears to be dispensable for humoral immune responses (Xu and Lam, 2001). Additionally, there is no direct evidence of BCMA cell surface expression on human lymphocytes since several evidences indicate the predominant expression of this receptor in the Golgi apparatus (Novak et al., 2004).

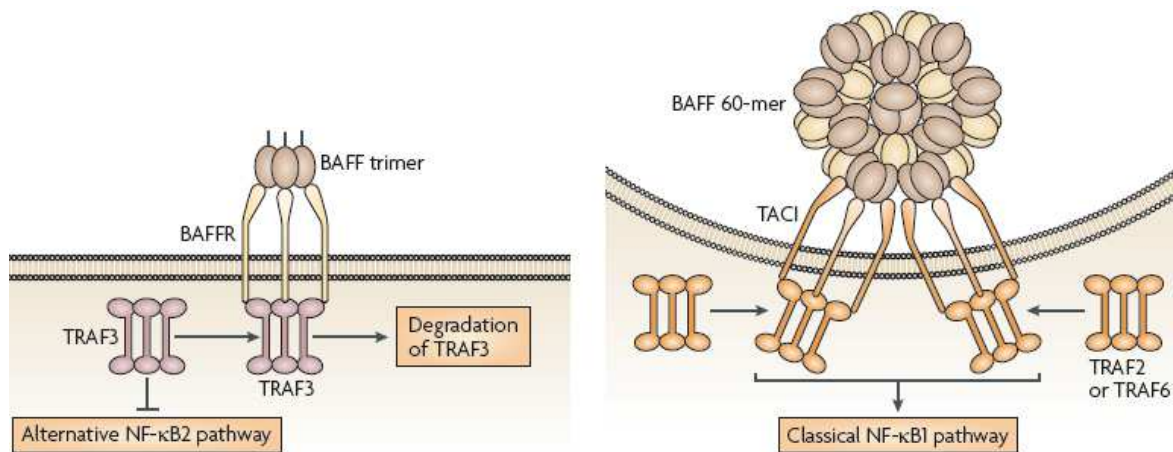
### **BAFF-R**

BAFF-R is the only BAFF-specific receptor and it has the structure of a type II transmembrane protein (Bülow and Bram, 1997). This receptor is expressed on transitional and mature B cells in mice while in humans BAFF-R is widely expressed by all B cells except for bone marrow plasma cells (Mackay and Schneider, 2009). In particular, the BAFF/BAFF-R pathway is crucial for the survival and growth of mature normal and malignant B cells. It is present on the plasma membrane but it is also found in the cellular cytoplasm, nuclear envelope and nucleoplasm (Fu et al., 2009). The expression of BAFF-R is not restricted to the B lineage as demonstrated by the evidence that a small subset of resting human and murine T cells present this receptor (Tangye et al., 2006). BAFF-R deficient mice show most of the

phenotypes of BAFF-deficient mice even if the absence of this receptor affects T cell-dependent and -independent humoral responses less seriously, suggesting that BAFF-R transmits important BAFF signals which are although partially compensated by the other BAFF receptors *in vivo* (Bossen et al., 2008). The fundamental role of BAFF in the survival of B cells is evident in BAFF-R deficient mice, since in this mice the maturation of MZ and B-2 cells is strongly impaired beyond the T1 stage (Mackay et al., 2003).

#### **1.3.4. BAFF signaling**

In general, the receptors of the TNF family bind to proteins with a TNF receptor associated factor (TRAFs) domain. TRAFs are intracellular signaling molecules that are recruited to three receptors held in the correct geometry by a trimeric ligand. These proteins are able to induce survival and apoptotic signals. In particular, TRAF recruitment can activate two signaling pathways: the Nuclear factor kappa-light-chain-enhancer of activated B cells (NF- $\kappa$ B) and the Mitogen-Activated Protein Kinase (MAPK) pathways. Specifically, the survival of B cells driven by BAFF is related to the induction of specific pathways associated with the activation of the NF- $\kappa$ B factor (Baud and Karin, 2001). When trimers of BAFF bind to BAFF-R we assist to the recruitment of TRAF3 that activates the alternative NF- $\kappa$ B2 pathway. Conversely, when 60 mer BAFF binds to TACI there is the recruitment of TRAF2 and TRAF6 that activate the classical NF- $\kappa$ B1 pathway (Fig. 1.18). The interaction between these pathways leads to ribosomic activation, mRNA transduction and finally to B cell survival and cellular growth (Mackay and Schneider, 2009).

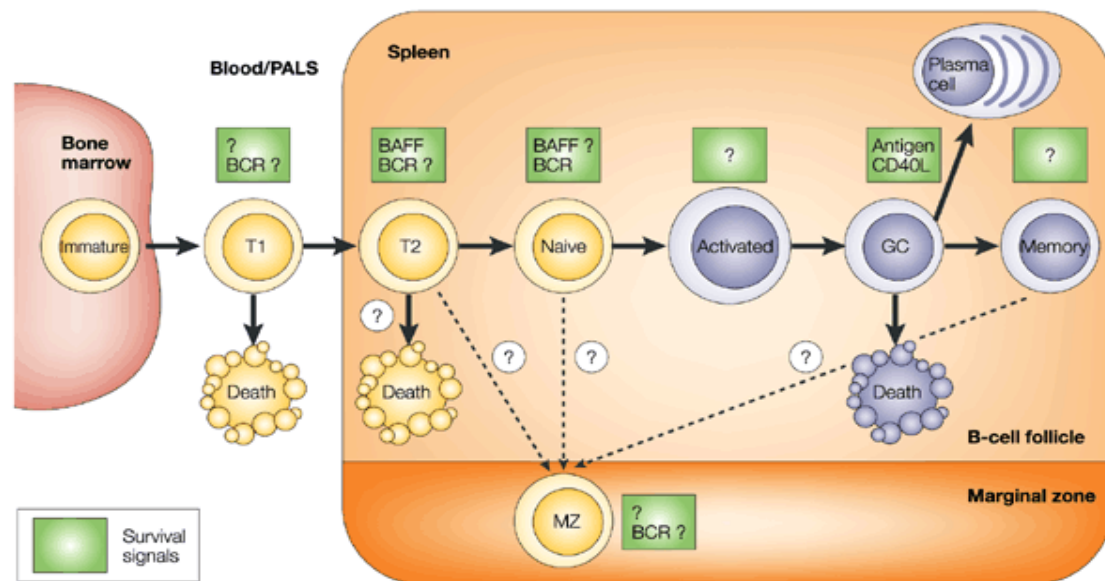


**Figure 1.18. BAFF signaling:** When the various forms of BAFF bind to their receptors, the TRAFs pathways are activated. This leads to B cell survival (modified from Mackay and Schneider, 2009).

### 1.3.5. Role of BAFF on B cell biology

BAFF plays a fundamental role in the immune system regulation because of its important role in B cell survival (Fig. 1.19). As already discussed in section 1.2.2 of this introduction, once B cells are generated in the bone marrow, they migrate to the spleen and they go through two intermediate stages called transitional type 1 (T1) and type 2 (T2), in order to complete their maturation process (Loder et al., 1999). Genetic analysis of the gain and loss of BAFF functions in mice show that the T2 stage is BAFF dependent, therefore this cytokine is very important for B cell survival and development. Transitional B cells cultured with BAFF acquire markers specific of mature B cells, demonstrating that BAFF may also be a maturation factor (Rolink et al., 2002). Conversely, data obtained in studies with BAFF deficient mice lead to conclude that BAFF does not seem to be essential for the development of B-1 cells (Batten et al., 2000).





**Figure 1.19. B-cell maturation process.** B cells coming from the bone marrow, enter the spleen and pass through two stages, T1 and T2, before maturity. To pass different stages they need a stimuli, one of this is BAFF (Mackay and Browning, 2002).

BAFF was shown to have a co-stimulatory effect in standard B cell activation assays using anti-IgM Abs (Schneider et al., 1999). In these experiments, BAFF behaves similarly to IL-4 or CD40L. However, BAFF alone does not induce B cell proliferation (Hsu et al., 2002). The crucial role of BAFF in B cell homeostasis has been established in experiments involving mice which over-expressed BAFF, since it was possible to observe B cell hyperplasia (Gross et al., 2000; Mackay et al., 1999). Moreover, Schneider and co-workers showed that mice in which BAFF was functionally blocked through the transgenic expression of the soluble form of TACI (TACI-Fc), presented a severe defect in mature B cells. The phenotype of TACI-Fc mice correlated with *in vitro* data implying that BAFF is a survival factor for transitional T2 B cells, pointing to a crucial role for BAFF in B cell development (Batten et al., 2000).

### 1.3.6. BAFF in autoimmunity

As previously described, BAFF is principally involved in B cell survival and maturation. When the level of this cytokine is “normal”, the B cell machinery works in the correct way.

Conversely, abnormal levels of BAFF may favor the survival and development of diverse B cell compartments, leading to autoimmune disease. Therefore, BAFF works as a double-edged sword in B cell biology: on one side it is a fundamental factor for B cell development but, on the other, its overproduction contributes to the exacerbation of B cell-dependent diseases. The levels of soluble BAFF are increased in several autoimmune pathologies: high levels of this cytokine have been observed in sera and in target organs of murine models of SLE (Gross et al., 2000), collagen-induced arthritis (CIA) (Zhang et al., 2005a), rheumatoid arthritis (RA), SjS (Cheema et al., 2001; Groom et al., 2002) and in chemically induced autoimmunity (Zheng et al., 2005). Similarly, this occurs also in patients that have other different autoimmune diseases. In support, BAFF transgenic mice develop severe autoimmune symptoms that are similar to SLE and SjS in humans (Mackay et al., 2003). Disease development is associated with indiscriminate B cell survival (Bosello et al., 2008; George-Chandy et al., 2008; Mariette et al., 2003). Interestingly, the levels of BAFF are correlated with disease activity and titers of pathogenic auto-Abs (Table 1.3) (Mackay et al., 2007a).

Pathological role of BAFF and APRIL in various diseases			
Disease	Observations in sub-group of patients	Source of excess BAFF/APRIL	References
<i>Autoimmune/allergic diseases</i>			
Systemic lupus erythematosus	Increased levels of BAFF, APRIL and BAFF/APRIL heterotrimers in sera. Correlation with anti-dsDNA autoantibodies and disease activity.	T cells, DCs and probably macrophages	[69]
Sjögren's syndrome	Increased levels of BAFF and APRIL found in sera and in salivary glands. Correlation with anti-Ro/La autoantibodies, rheumatoid factor and total IgG.	T cells, macrophages and epithelial cells	[1]
Rheumatoid arthritis	Increased levels of BAFF, APRIL and BAFF/APRIL heterotrimers found in sera and joint synovial fluid. Correlations with anti-GPI antibodies (APRIL) and rheumatoid factor (BAFF).	Macrophages, DCs and neutrophils	[1,103,104]
Multiple sclerosis	Increased levels of BAFF and APRIL found in spinal fluid and in neurological lesions.	Astrocytes and monocytes	[26,105]
Wegner's granulomatosis	Increased serum levels of BAFF.	?	[106]
Bullous pemphigoid	Increased serum levels of BAFF.	?	[107]
Myasthenia gravis	Elevated levels of BAFF in the thymic medulla may support pathogenic B cells present in the thymus.	Macrophages, DCs, lymphocytes and epithelial cells	[108]
Asthma	Excess serum levels of BAFF in IgE- and non-IgE-associated disease. Correlated with severity of asthmatic symptoms.	?	[109]
<i>Infectious disease</i>			
Epstein-Barr virus (EBV)	EBV-encoded LMP1 induces abnormal expression BAFF and APRIL by B cells, which might confer susceptibility to cancer.	B cells	[110]
Human immunodeficiency virus	Elevated BAFF levels in infected patients. Associated with anti-phospholipid autoantibodies.	Myeloid cells	[111]
Hepatitis C infection	Elevated BAFF in sera. Associated with HCV-related SLE, arthralgia and vasculitis.	?	[112]
<i>Cancer</i>			
Hodgkin's lymphoma	Elevated BAFF and APRIL in tumour environment. Binds to TACI and BCMA on malignant B cells, conferring increased survival.	Cancerous B cells and immune infiltrate	[78]
Non-Hodgkin's lymphoma	Elevated BAFF in tumour environment and sera. Binds to TACI and BAFF-R on malignant B cells, conferring increased survival. Higher BAFF levels correlate with aggressiveness of tumour and poor disease outcome.	Cancerous B cells and macrophages	[81,84]
B-cell chronic lymphocytic leukaemia	Elevated BAFF and APRIL in tumour environment and sera. Binds to TACI and BAFF-R on malignant B cells, increasing survival.	Cancerous B cells and nurse-like cells	[5]
Waldenström's macroglobulinaemia	Elevated BAFF in sera and bone marrow environment of tumour. Binds primarily to BAFF-R and TACI on tumour, enhancing survival. BAFF induces IgM production by tumour.	Cancerous B cells	[79]
Multiple myeloma	Excess BAFF and APRIL in sera and bone marrow environment of tumour. Binds primarily to BCMA and TACI on tumour cells, enhancing survival. Low TACI expression by cancer associated with bad prognosis.	Cancerous B cells, monocytes, neutrophils, stromal cells and osteoclasts	[85,86,113]

**Table 1.3.** Pathological role of BAFF in different diseases. (Mackay et al., 2007a)

The contribution of BAFF to autoimmunity is confirmed by the therapeutic benefit gained by its neutralization. Indeed, lower or delayed levels of BAFF are detected in SLE-prone mice treated with TACI-Ig or BAFF-R-Ig fusion proteins, leading to the survival of these mice. TACI-Ig and BAFF-R-Ig affect mature FO and MZ B cells, without influencing the B-1 cell population (Gordon et al., 2003; Gross et al., 2000; Ramanujam et al., 2004, 2006). Moreover, BAFF antagonists conferred protection also in multiple sclerosis (Huntington et al., 2006) and in mice models of RA (Mackay et al., 2003; Wang et al., 2001). This last point is particularly relevant since, in patients with RA, the increased BAFF levels detected in the sera and synovial fluid may increase B cell survival; thus the neutralization of BAFF represents an

alternative therapeutic approach to target pathogenic B cells (Bosello et al., 2008; Ohata et al., 2005). Nowadays, several Abs directed against human BAFF are used in clinical trials. One of these is a monoclonal Ab (mAb), called Tabalumab, that neutralizes both the membrane and soluble form of human BAFF (Genovese et al., 2013). As reported by Genovese and coworkers, Tabalumab reduced RA signs and symptoms with the same efficacy of the TNF inhibitors, routinely used in the treatment of this autoimmune disease (Genovese et al., 2013). RA is not the only pathology in which anti-BAFF mAb have been used. Another disease in which the blocking of BAFF is utilized as a therapy to solve autoimmunity is SLE. In the last 50 years, no new drug for SLE has been approved; indeed, the last drugs accepted by the FDA were Plaquenil (hydroxychloroquine) and corticosteroids, in 1955. The conventional therapy for this disease involves the use of drugs such as non-steroidal anti-inflammatory drugs, corticosteroids, anti-malarial agents, and immunosuppressant drugs that are aimed to reduce inflammation and unspecifically suppress the immune system (Doria and Iaccarino, 2013). Belimumab is a fully humanized mAb that binds to the soluble form of BAFF and inhibits its biological activity (Ding and Gordon, 2013). Belimumab was tested with good prognosis and represents a new expectation for all SLE patients, underlining the really important role of BAFF in this autoimmune disease (Specchia et al., 2014).

### **1.3.7. BAFF in tumors**

In the medical field, BAFF has been studied above all for its role in B cell survival and for its consequent involvement in autoimmune diseases. In the last few years, the role of this cytokine has been investigated also in tumors. Indeed, there are different evidences that show how BAFF, and also APRIL, are involved in B cell malignancies such as Waldenström macroglobulinemia (WM), Hodgkin's lymphoma (HL), non-Hodgkin's lymphoma (NHL), chronic lymphocytic leukemia (B-CLL), and MM (Chiu et al., 2007; ElSawa et al., 2006;

Kern et al., 2004; Novak et al., 2002). This is demonstrated in transgenic mice which over-expressed this cytokine, thus an increase incidence of B cell lymphomas was observed in each case (Batten et al., 2004). In humans, high levels of BAFF have been detected in sera and tumor microenvironment of patients that have various mature pathologies of the B cell lineage. However, cytokine expression has been detected in non-lymphoid breast cancer cells from epithelium origin (Pelekanou et al., 2008) and this evidence indicates that the role of BAFF in tumors might be more wide than first thought. In general, BAFF contributes to the survival of neoplastic B cells and this has important implications in oncology (Mackay and Tangye, 2004). BAFF can be produced by cancer cells (autocrine survival factor) or by the cells supporting tumor growth and constituting the tumor microenvironment niche (paracrine survival factor). This is particularly evident in NHL, where the aberrant production of BAFF by the malignant B cells themselves or by the supporting immune cells may facilitate their growth and survival (Tangye et al., 2006). In these pathologies, malignant B cells are all capable of binding soluble BAFF and this ability is functionally significant since *in vitro* experiments demonstrated that exogenous BAFF promotes the proliferation and/or the survival of B-CLL-, NHL-, MM- and WM-derived B cells (Elsawa et al., 2006; He et al., 2004; Moreaux et al., 2003; Novak et al., 2002). Of particular interest is the role of BAFF in MM, an hematologic malignancy characterized by the accumulation of monoclonal plasma cells in the bone marrow (Tai et al., 2006). In almost all cases, MM is preceded by a premalignant disease, known as monoclonal gammopathy of undetermined significance (MGUS) (Landgren et al., 2009; Weiss et al., 2009). The biological transition from normal plasma cells to MGUS and MM consists of many oncogenic events. An early event described in MGUS, as well as MM, is the dysregulation of a cycline D gene (Bergsagel et al., 2005). In the onset and development of MM two fundamental steps can be identified: the initiation phase, in which one clone of plasma cells acquire genetic alterations, and a progression phase, in which the complexity and alteration in plasma cells increased (Morgan and Kaiser, 2012).

Interestingly, Vacca and colleagues demonstrated that bone marrow microvascular density was significantly increased in MM compared to MGUS (Vacca et al., 1994). Moreover, to understand the biology of MM, one must study the bone marrow microenvironment that is made of a cellular compartment (stromal fibroblasts, osteoblasts, osteoclasts, endothelial cells and other immune cells) and a non-cellular compartment that includes the extracellular matrix and the liquid milieu, with cytokines, growth factors and chemokines (Ghobrial, 2012). Indeed, in MM, the bone marrow niche, plays an important role in differentiation, migration, proliferation, survival and drug resistance of the malignant plasma cells providing preclinical evidences for targeting MM cells and bone marrow stromal cells. Among the cytokines found in the tumor microenvironment, a relevant role is played by BAFF. It has been demonstrated that both myeloma cell lines and primary myeloma cells express BAFF and their receptors (Moreaux et al., 2004) and that BAFF can lead to the survival of malignant plasma cells in myeloma, playing an important role in tumor progression and sustenance (Novak et al., 2004). For these reasons, in MM, BAFF could represent a potential diagnostic factor and, above all, a possible target towards which drug therapy could be directed.

## **2. AIMS OF THE WORK**

The MC is a cell of the immune system well known for its role in allergy and in the defense against pathogens. Recent studies have shown that MCs play also an important role in the homeostasis of the immune system by interacting with different immune cell types (Gri et al., 2012). Defined by Frossi and colleagues as “the antenna of the microenvironment”, in recent years it has been shown that the MC is not only implicated in allergy, but it is also involved in several processes in the immune system (Gri et al., 2012). Therefore, MCs have a versatile physiological function and they should no longer be considered simply as “allergic cells” (Garfield et al., 2006; Maurer et al., 2004). MCs can interact with other cell types and this renders the study of the role of these cells increasingly complex and prominent. Finally, MCs have also a role in tumors, although their specific mechanism of action is not yet clear.

B cells require multiple and diverse signals for their development and differentiation in effector cells. Depending on the nature of the Ag and of the second signal, B cells can be activated in a T cell-dependent or -independent manner. Previous work done in the laboratory in which this project was performed, demonstrated that MCs are able to activate B cells and regulate their effector functions. Indeed, MCs enhance B cell proliferation and drive their differentiation towards IgA secreting plasma cells. A fundamental role in the interaction between MCs and B cells is played by the CD40/CD40L axis, but also soluble factors are involved (Merluzzi et al., 2010).

It has been recently demonstrated that neutrophils, through the production of BAFF, provide fundamental stimulating signals to the B cell, including signals activating CSR and SHM (Mackay and Browning, 2002). Therefore we were interested in assessing whether BAFF

could be a previously unknown element linking the interaction between MCs and B cell and the processes of CSR and SHM.

Starting from these considerations we have investigated the presence of BAFF on MCs and its involvement in the B/MC interaction. In the first part of this study, the experiments were designed in order to assess whether MCs could produce BAFF. After that, the work was focused on the understanding of the role of BAFF in the context of B/MC interaction, both in physiological and pathological states. In light of the discovery of increased MC numbers in MM (Ribatti et al., 1999) and of the important role played by BAFF in this B cell malignancy (Groom et al., 2002; Haiat et al., 2006) , we decided to study the involvement of MC-derived BAFF in the context of MM.



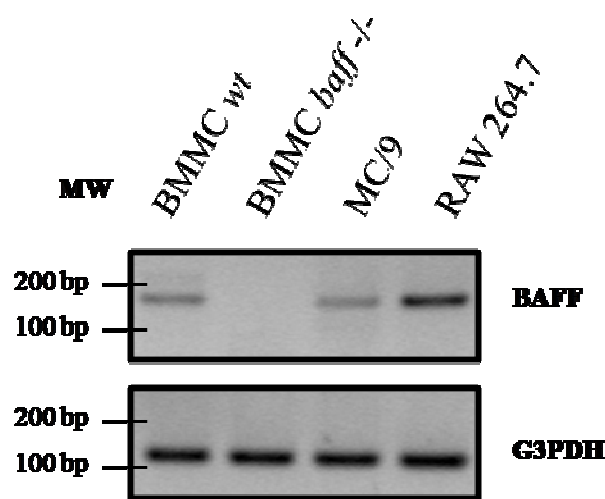
## **3. RESULTS AND DISCUSSION**

### **3.1. INVESTIGATION OF BAFF PRODUCTION IN MAST CELLS**

#### **3.1.1. BAFF gene expression in murine and human MCs**

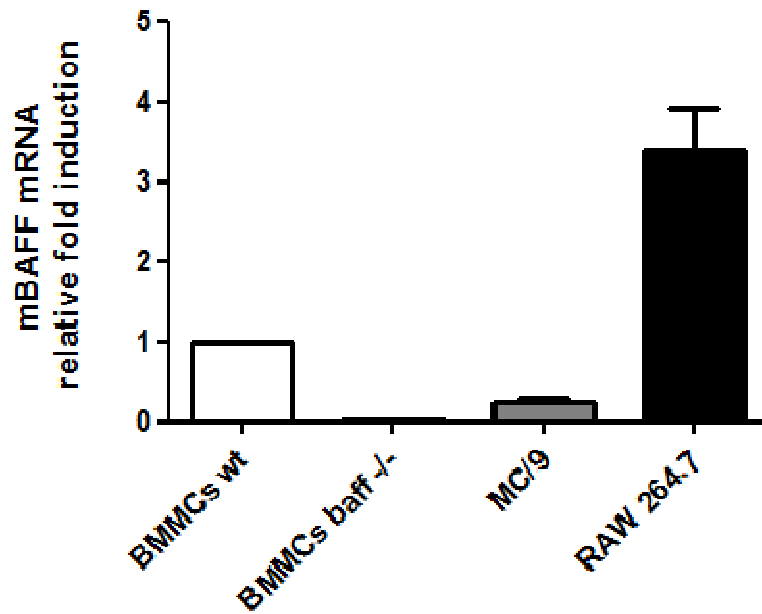
It is now well established that defining the MC as a mediator of the allergic response is definitely an understatement given the growing body of evidence underlining the pivotal role of this cell in the protection against pathogens and in the regulation of both innate and adaptive immunity (Gilfillan and Beaven, 2011). An important role in MC ability to modulate the immune response is played by the crosstalk between members of the TNF superfamily and their receptors. Several studies have shown the importance of the direct interaction between MC-expressed OX40L and T cell OX40 in the induction of T cell proliferation (Jun-ichi Kashiwakura, Hidenori Yokoi, 2004; Nakae et al., 2006), and in the inhibition of Treg suppressive activity, and consequent Th17 cell differentiation (Piconese et al., 2009). In the context of the B cell-MC crosstalk, a key role is played instead by the CD40-CD40L interaction which not only promotes B cell survival and proliferation but also contributes to MC-driven expansion of IL-10-competent B cells (Merluzzi et al., 2010; Mion et al., 2014b). Similarly to other TNF family ligands, BAFF is a type II transmembrane protein that plays a fundamental role in B cell development and survival (Mackay et al., 2003). Although the GeneChip data of a study conducted by Mackay's group in 2004 showed that transcripts of BAFF were expressed in MCs (Ng et al., 2004), no one, to our knowledge, has ever examined in depth such result. In order to better elucidate the regulation of BAFF production in MCs, we decided to first examine BAFF gene expression in both murine and human MCs at the mRNA level. Concerning the murine setting, levels of endogenous BAFF transcripts were assessed by reverse transcriptase polymerase chain reaction (RT-PCR), both in wild type bone

marrow-derived MCs (BMMCs *wt*) and in the mouse MC/9 MC line. In parallel, the experiment was performed with the murine macrophage-like cell line RAW 264.7, which has been reported to express BAFF gene under basal conditions (Kim et al., 2008), and in BAFF-deficient BMMCs (BMMCs *baff*<sup>-/-</sup>). As shown in Fig. 3.1, both *wt* BMMCs and MC/9 expressed sufficient BAFF mRNA to give a positive signal although the intensity of the bands were weaker compared to the RAW 264.7 condition. Consistently, no PCR product was instead observed for the negative control condition, represented by BAFF-deficient BMMCs.



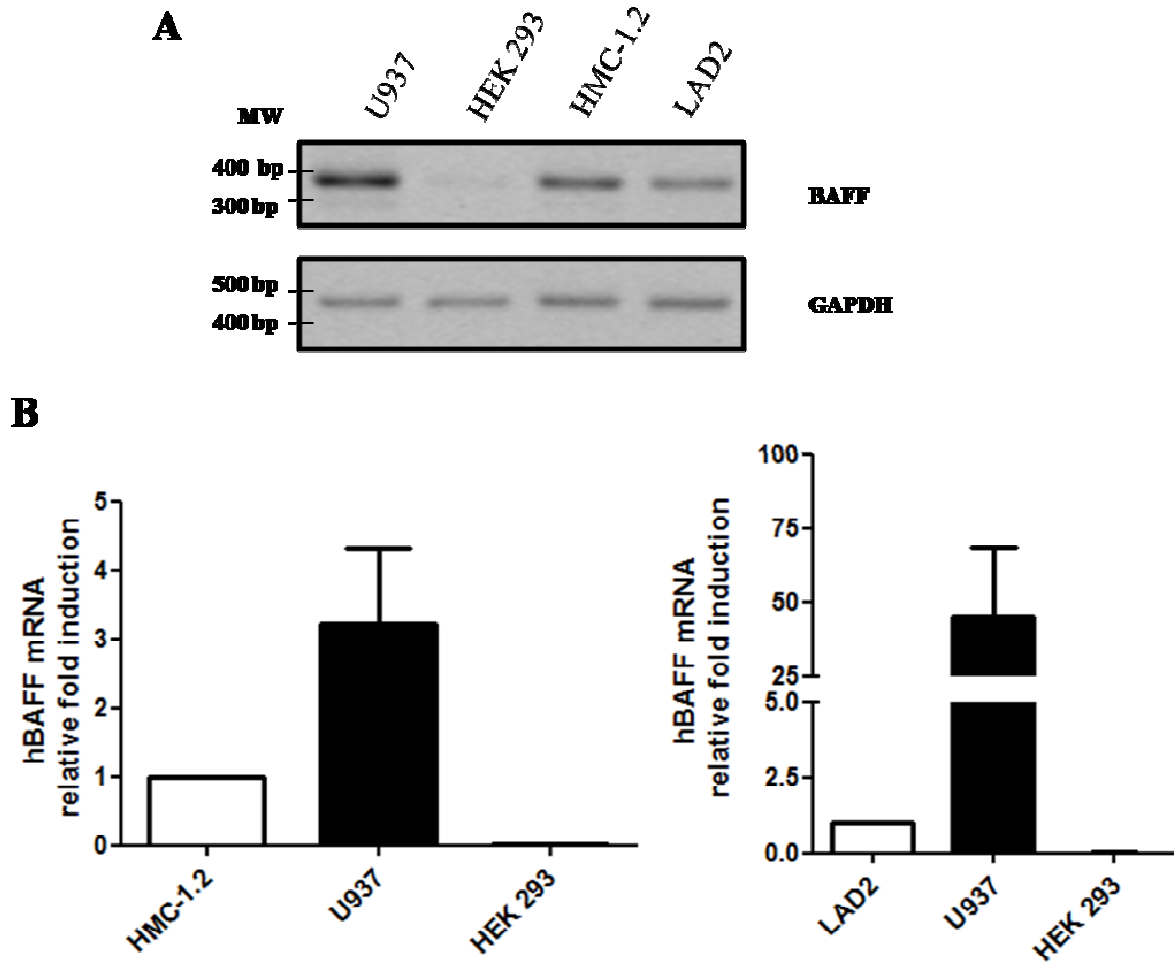
**Figure 3.1. BAFF gene expression in murine MCs.** The presence of BAFF mRNA was determined by RT-PCR in wild type (BMMC *wt*) and BAFF-deficient (BMMCs *baff*<sup>-/-</sup>) MCs and in the murine cell lines MC/9 and RAW 264.7. RAW 264.7 and BAFF-deficient MCs (BMMCs *baff*<sup>-/-</sup>) represent respectively the positive and negative controls. Control amplifications (G3PDH) are also shown. Images are representative of results from at least three independent experiments.

In order to have a quantitative measurement of BAFF gene expression, experiments of real time PCR (qPCR) were performed and results were expressed as fold induction compared to the *wt* BMMCs condition (Fig. 3.2). The levels of BAFF mRNA expression were about three times higher in RAW 264.7 than in *wt* BMMCs, indicating that, under basal conditions, MCs might produce lower amounts of BAFF compared to macrophages.



**Figure 3.2. Murine MCs express BAFF mRNA.** The relative level of BAFF mRNA was determined by qPCR in wild type (BMMCs wt) and BAFF-deficient (BMMCs baff<sup>-/-</sup>) MCs and in the murine cell lines MC/9 and RAW 264.7. RAW 264.7 and BMMCs baff<sup>-/-</sup> represent respectively the positive and negative control. In all tested conditions the expression levels are shown as fold induction over wt BMMC. The G3PDH transcript levels were used to normalize samples. Results of three experiments for wt, baff<sup>-/-</sup>, RAW 264.7 and two experiments for MC/9 are shown as mean values plus SEM.

Since murine and human MCs share several similarities but also present some differences (Bischoff, 2007), we decided to investigate whether the result relative to BAFF expression could stand true also in the human system. Unfortunately, it is not easy to obtain and work with primary human MCs (Guhl et al., 2010) and therefore the experiments were performed using two different human MC lines, HMC-1.2 and LAD2, which are extensively used despite their many limitations. As for the murine system, human BAFF gene expression was assessed through both RT-PCR and q-PCR, using the human cell lines U937 and HEK 293, respectively as positive and negative controls (Daridon et al., 2007). Both techniques demonstrated that BAFF transcripts levels were higher in HMC-1.2 than in HEK 293 cells (Fig. 3.3A, B). Also LAD2 cells resulted positive in comparison to the negative control although the levels of BAFF expression seemed much lower than the ones detected in HMC-1.2 cells (Fig. 3.3A, B).



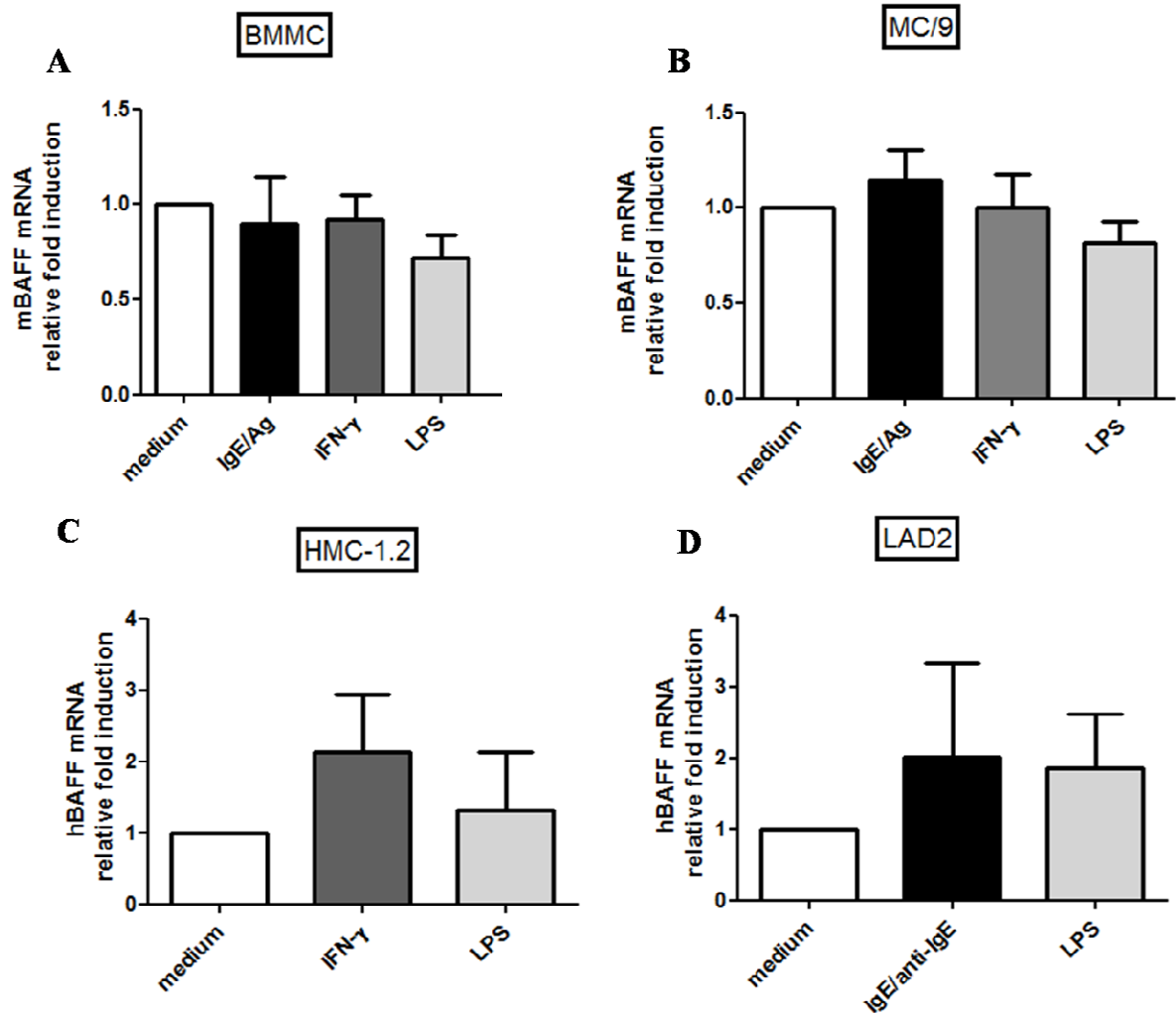
**Figure 3.3. BAFF gene expression in human MCs.** (A) A representative RT-PCR analysis and (B) the quantitative real time PCR result of  $n=3$  independent experiments are presented for both the HMC-1.2 and the LAD2 cell lines. U937 and HEK 293 cells served respectively as positive and negative controls.

### 3.1.2. Effects of IgE-dependent and -independent MC-stimulation on BAFF expression

After confirming BAFF gene expression under basal conditions in both human and murine MCs, we further investigated if BAFF transcript levels were affected by the addition of stimuli known to affect the biology of the MC. Indeed, several reports described a variation of BAFF expression and production in response to cell stimulation. The kind of variation was shown to be cell- and stimulus-dependent: while RAW 264.7 were shown to increase BAFF

production following stimulation with either IFN- $\gamma$  or TGF- $\beta$  (Kim et al., 2008), neutrophils were reported to dramatically activate the novel synthesis of BAFF in response to G-CSF or IFN- $\gamma$  (Scapini et al., 2003).

The particular nature of the MC renders this cell type particularly sensitive to activation by means of several and different kind of stimuli, not necessarily related to the binding of the IgE-Ag complex by Fc $\epsilon$ R. Although a variety of classical MC agonists could up-regulate BAFF gene and protein expression, we decided to test the effect of the classical IgE/Ag stimulation and of LPS and IFN- $\gamma$ , which have been both related to BAFF production by DCs, macrophages, and activated T cells (Huard et al., 2004). Murine MCs were cultured for 5 h in the presence or absence of the aforementioned stimuli before being collected and lysed for RNA extraction. As shown in Fig. 3.4, no significant variation in BAFF gene expression was observed in either BMMCs (panel A) or in MC/9 (panel B) after treatment with IgE/Ag, IFN- $\gamma$  or LPS, indicating that these stimuli alone are not able to affect the basal expression of BAFF observed in murine MCs. A similar outcome resulted also from HMC-1.2 (panel C) and LAD2 (panel D) stimulation, although an increase in BAFF gene expression (which did not reach statistical significance) was observed for IFN- $\gamma$ -stimulated HMC-1.2.



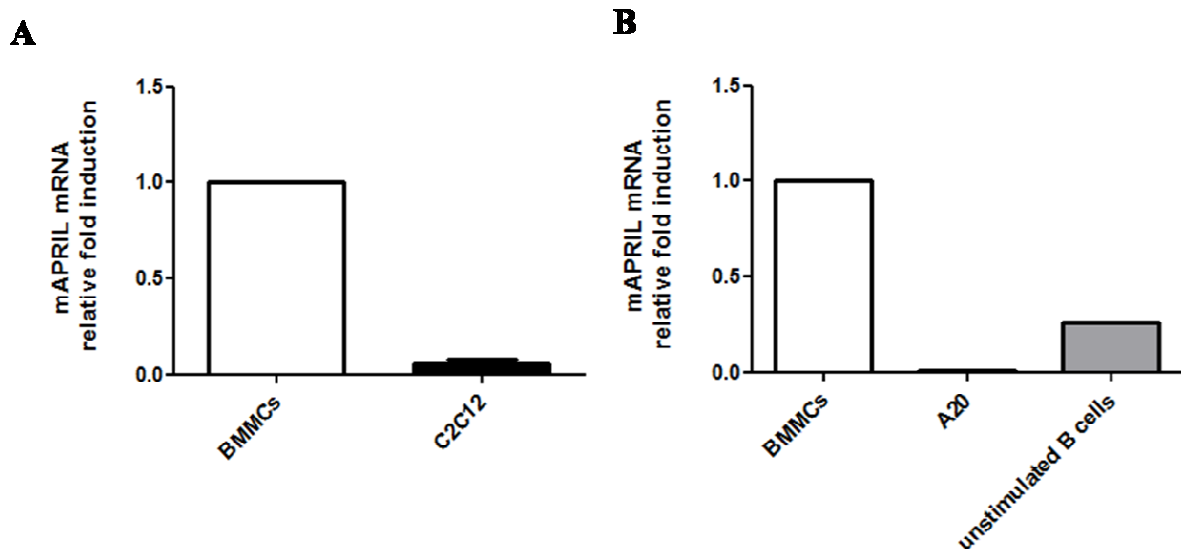
**Figure 3.4. Effect of MC-stimulation on BAFF expression.** BMMCs (A) and the MC/9 (B), HMC-1.2 (C) and LAD2 (D) cell lines were cultured with medium alone or stimulated for 5 h with IFN- $\gamma$ , LPS or through Fc $\epsilon$ R, as described in the materials and methods section. Cells were lysed for RNA extraction and BAFF expression was assessed by qPCR. In all tested conditions the expression levels are shown as fold induction over unstimulated MCs (NST). Reported results show means ( $\pm$  SEM) from at least three independent experiments for BMMC, MC/9 and HMC-1.2, and  $n=2$  experiments for the LAD2 condition.

### 3.1.3. APRIL gene expression in MCs

As already mentioned in the introduction of this thesis, APRIL is a TNF ligand with close homology to BAFF, with which it shares several functions within the B cell arm of the immune system (Ng et al., 2005). While the full-length form of BAFF is cleaved preferentially at the cell surface, APRIL is processed inside the cell by a furin-convertase and is able to exert its function only as a soluble factor (Daridon et al., 2008). The important role

of APRIL, together with its relation to BAFF, makes the study of this protein very interesting. Thus, we decided to assess whether this cytokine could be produced by murine MCs.

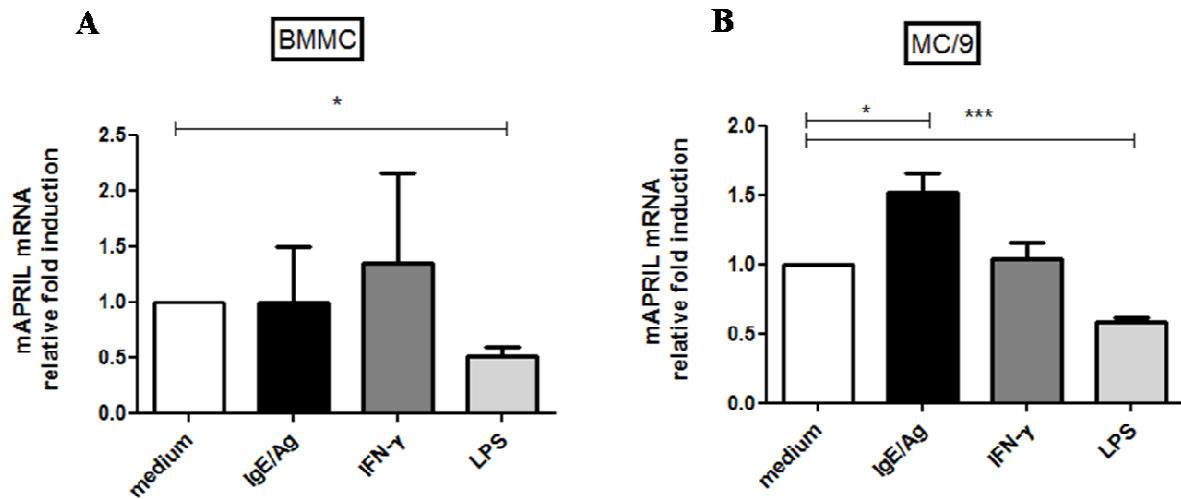
Since we did not have the possibility to work with APRIL-deficient BMMCs, the level of APRIL gene expression in MCs was compared with those of cell types for which the production of this cytokine has not been described in literature. As shown in Fig. 3.5 APRIL transcripts were detectable under basal conditions in BMMCs but not in murine C2C12 myoblasts (Fig. 3.5A) and in the A20 B cell lymphoma line (Fig. 3.5B).



**Figura 3.5. Murine MCs express APRIL mRNA.** The relative level of APRIL mRNA was determined by qPCR in BMMCs and C2C12 (A) and in BMMCs, A20 cell line and unstimulated B cells (B). C2C12, A20 and unstimulated B cells present the negative control. In all tested conditions the expression levels are shown as fold induction over BMMCs. The G3PDH transcript levels were used to normalize samples. Results of two independent experiments for A panel and one for B panel. The experiments are shown as mean values plus SEM.

Furthermore, the effect of IgE/Ag, LPS and IFN- $\gamma$  stimulation was tested both in BMMCs and in the MC/9 cell line. Contrary to what observed in the case of BAFF expression, for which there was no difference in the presence or absence of stimulation, LPS decreased APRIL transcript levels, in both BMMCs and MC/9, while IgE/Ag activation augmented the expression of this cytokine in MC/9 cells (Fig. 3.6). Although these results need to be studied

in more detail, they constitute a good starting point for future investigations regarding the role of this cytokine in the B/MC crosstalk.



**Figure 3.6. APRIL gene expression following MC-stimulation.** BMMCs (A) and MC/9 (B) were cultured with medium alone or stimulated with IgE/Ag, IFN- $\gamma$  or LPS for 5 h. APRIL gene expression was assessed by qPCR and the G3PDH transcript levels were used to normalize samples. In all tested conditions the expression levels are shown as fold induction over unstimulated MCs (medium). Reported results show means ( $\pm$  SEM) from at least three independent experiments.

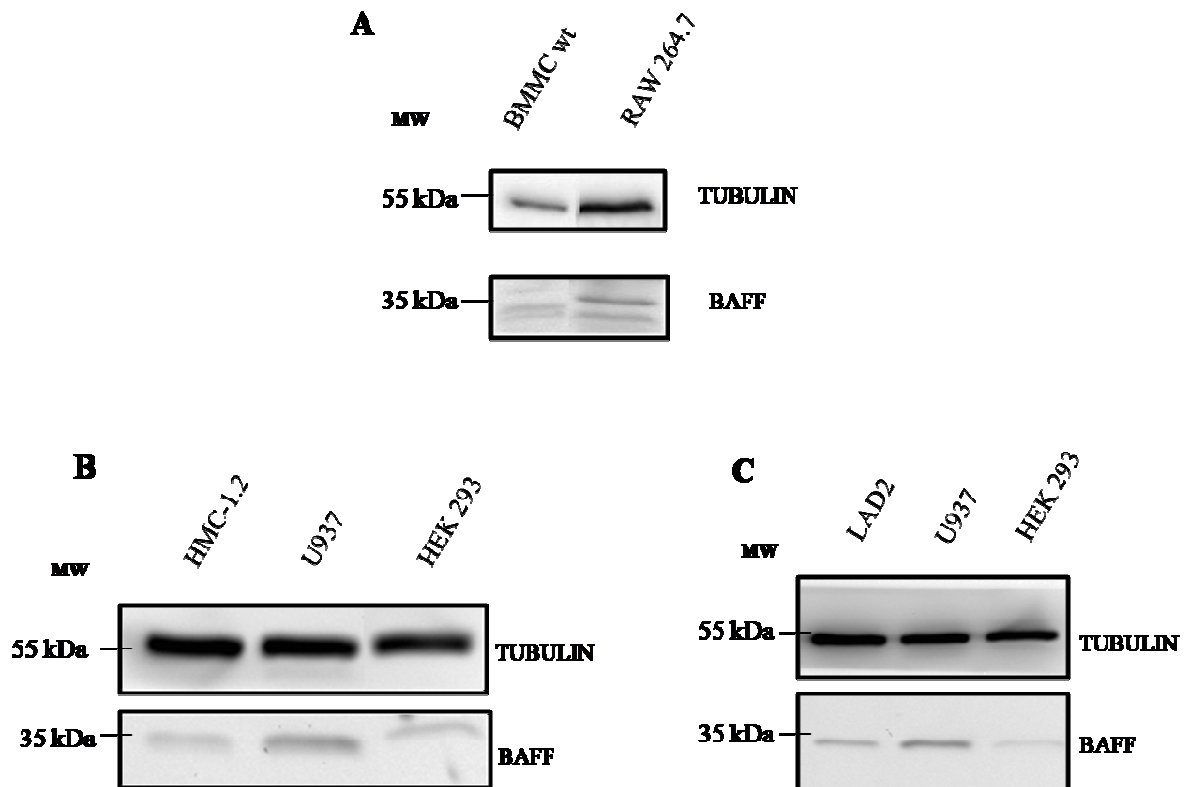
#### 3.1.4. Full-length BAFF production by MCs

Transcription level data can give information whether or not a protein of interest is present in a cell. In light of the results obtained at the mRNA level, we decided to deepen the study of BAFF expression in MCs and focus on protein production.

We first analyzed BAFF synthesis in the murine context, by western blot analysis. BMMCs and RAW 264.7 cells were collected, washed twice with ice-cold PBS and incubated for 30' at 4°C, under gentle rotation, with 1% NP-40 in lysis buffer. Whole cell extracts were quantified through Bradford assay and resolved by 12% SDS gel electrophoresis, before being probed with anti-BAFF and anti-tubulin Abs. Both in the RAW 264.7 and BMMC samples, the immunoblot analysis revealed the presence of a protein band in correspondence of the expected molecular weight of the full length form of BAFF (31-35 kDa), confirming the production of BAFF protein by murine MCs (Fig. 3.7A). Similarly, western blot analysis was

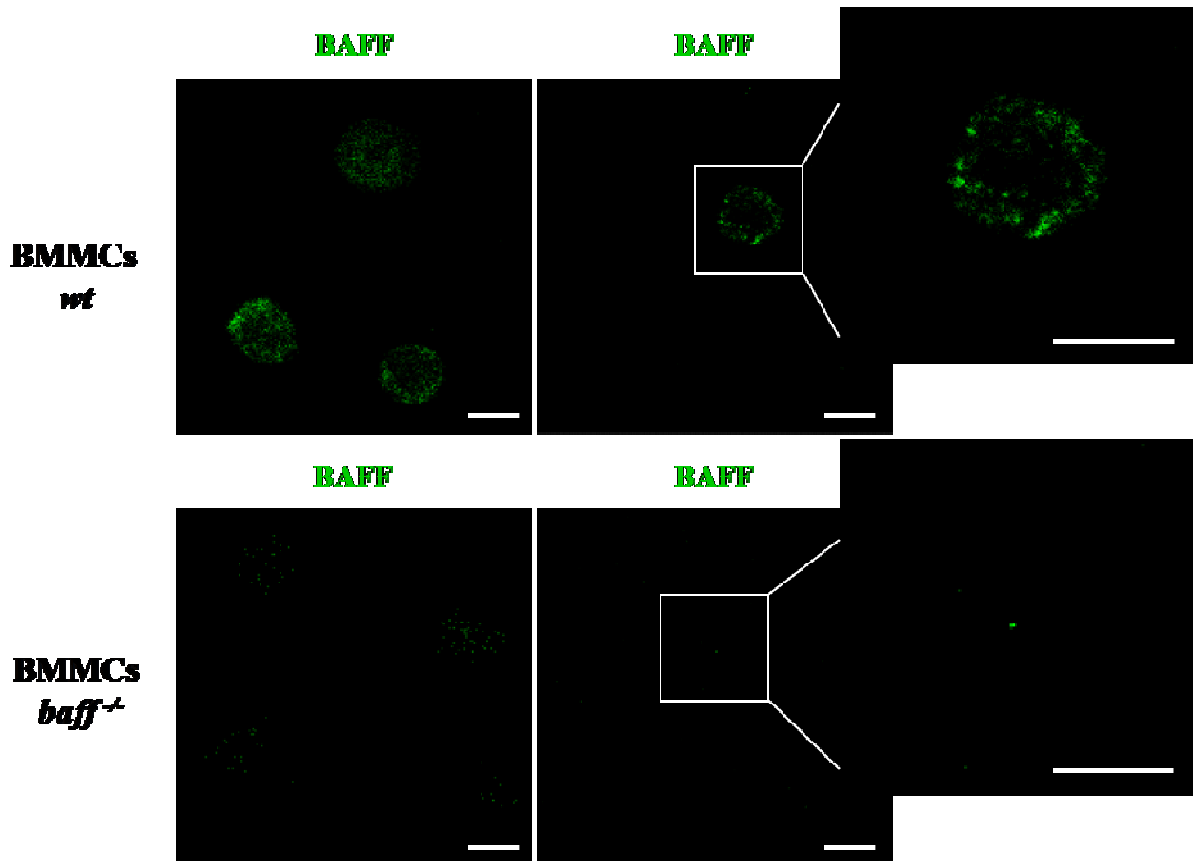


performed on lysed samples of HMC-1.2 and LAD2 MCs and of U937 and HEK 293 cells, which served respectively as positive and negative controls. As shown in Fig. 3.7, BAFF protein was detected in total lysates from U937 cells and, to a lesser degree, in that from HMC-1.2 (panel B) and LAD2 (panel C) cells.



**Figura 3.7. Representative WB images of BAFF expression in murine and human MCs.** The protein samples from the indicated cells in murine system (A) and human system (B, C) were detected by Western Blotting using murine and human anti-BAFF. BAFF protein in murine cells (about 35 kDa band) in human cells (about 31 kDa band), tubulin (55 kDa band) was used as a control for equal loading of cell lysates.

Production of full-length BAFF was further validated by confocal microscopy analysis of BMMCs, which showed the presence of this cytokine mostly at the level of cell membrane (Fig. 3.8). The specificity of BAFF staining was checked by comparing *wt* (upper panel) and BAFF-deficient (lower panel) BMMCs.



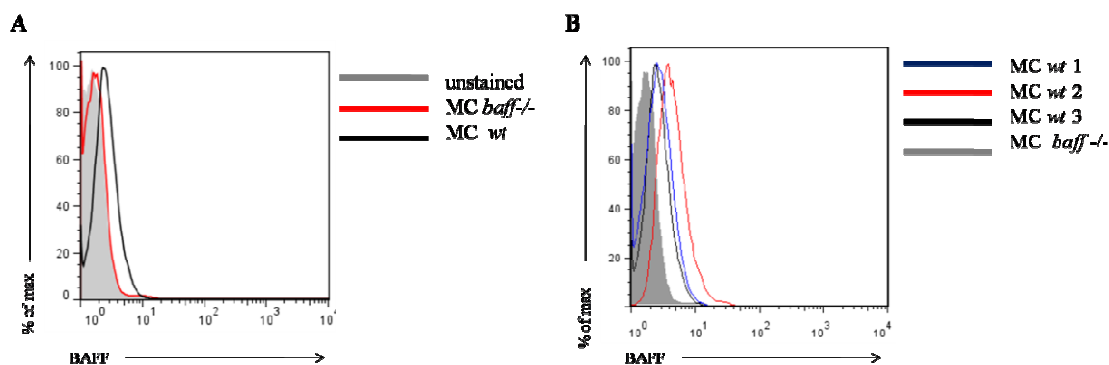
**Figure 3.8. Representative confocal images of BAFF expression in murine MCs.** Immunofluorescence analysis on wt BMMCs was performed using a FITC-labeled anti-BAFF Ab to identify BAFF-positive cells. BAFF-deficient MCs (*baff*<sup>-/-</sup> BMMCs) served as negative controls for BAFF staining. All pictures were taken under 63x magnification. Bar = 10  $\mu$ m.

### 3.1.5. Regulation of membrane-bound and soluble BAFF production in MCs

In most cell types, BAFF is localized on the cell membrane where it can be cleaved by a furin-like protease, to generate the soluble form of this cytokine. However, it has been shown that the soluble form can be also produced by the cleavage of full length BAFF that occurs intracellularly (Scapini et al., 2003), broadening the complexity of BAFF investigation. In addition, several studies have reported a different potency of membrane-bound and soluble BAFF. Although in the past soluble BAFF was believed to be the predominant form of this protein, in 2008 Schneider's group demonstrated that cells expressing a non-cleavable membrane-bound form of BAFF were at least 50-fold more active than soluble BAFF at delivering signals to responder cells (Bossen et al., 2008). The evidence that the membrane

form can have distinct roles compared to the soluble form has also been reported by a recent study showing that depending on the context, membrane-bound BAFF can be a more potent stimulus than cleaved soluble BAFF (Manetta et al., 2014). In light of all this evidence, we decided to investigate the production of the two different forms of BAFF by MCs, under basal conditions.

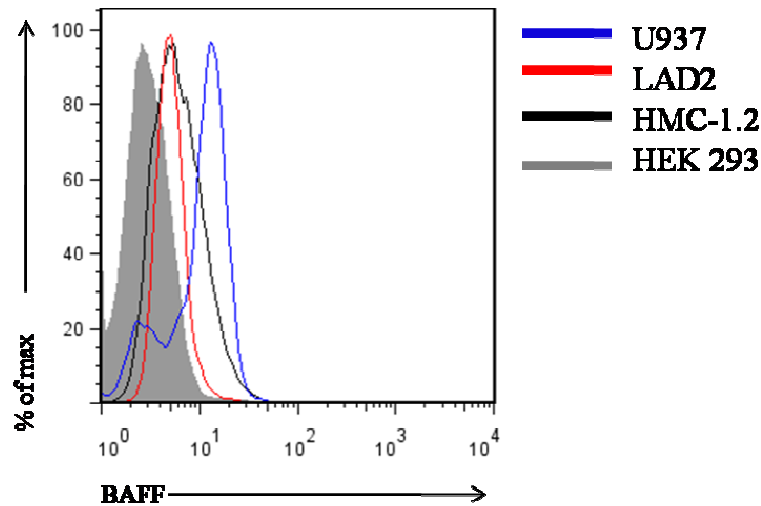
The expression of membrane-bound BAFF was assessed by flow cytometry analysis, in both the murine and human setting. Regarding BMDCs, protein expression was analyzed in *wt* and *baff*<sup>-/-</sup> MCs and revealed the presence of a marked difference between the two conditions (Fig. 3.9A). However, similarly to the co-stimulatory molecule CD40L (Merluzzi et al., 2014), the expression of BAFF seemed to vary based on the specific BMDC culture in analysis (differentiation stadium, age of culture, heterogeneity of precursor cells, which may vary from mouse to mouse, etc.). Indeed, as shown in Fig. 3.9B, MCs deriving from three different BMDC cultures produce different amounts of BAFF.



**Figure 3.9. Flow cytometry analysis of membrane-bound BAFF expression in human MCs.** (A) Surface expression of BAFF was analyzed by flow cytometry on *wt* (black histogram) and *baff*<sup>-/-</sup> (red histogram) bone marrow MCs, using a FITC conjugated anti-murine BAFF Ab (clone Buffy-2). The filled histogram represents the unstained sample. A representative histogram is shown here for three independent experiments. (B). BAFF expression levels in three different BMDC cultures are compared. As a control, the *baff*<sup>-/-</sup> condition is reported.

Concerning the human system, membrane-bound BAFF was analyzed both in the HMC-1.2 and in LAD2 cell lines, using U937 and HEK 293 cells as positive and negative controls respectively. In accordance with previously published data (Nardelli et al., 2001b), U937 cells

expressed high amounts of cell-surface BAFF while the cytokine was present at lower levels on HMC-1.2 and LAD-2. Nevertheless, BAFF staining on human MCs was positive compared to the HEK 293 negative control cell line (Fig. 3.10).

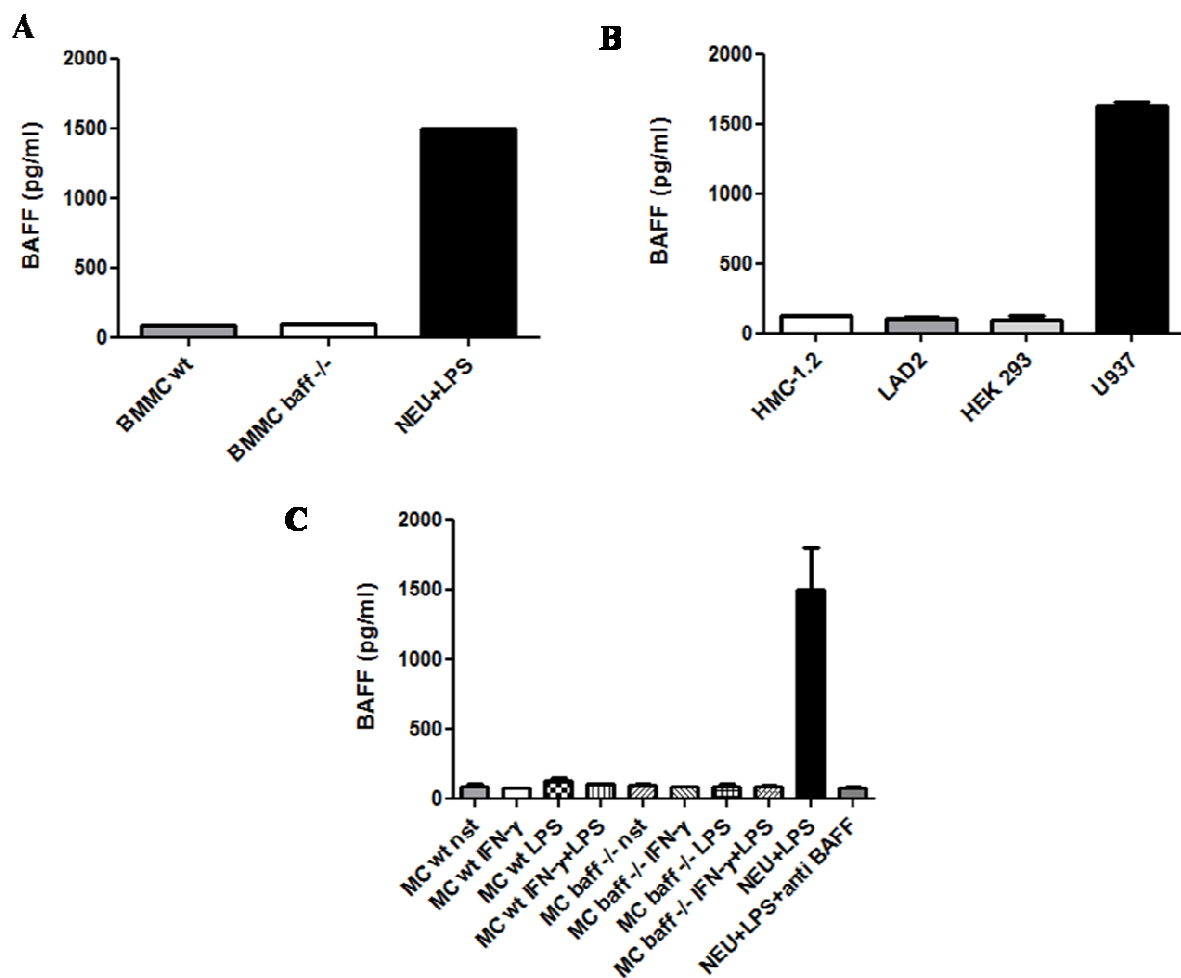


**Figure 3.10.** Flow cytometry analysis of membrane-bound BAFF expression in human MCs. The U937 (blue histogram), LAD2 (red histogram), HMC-1.2 (black histogram) and HEK 293 (grey filled histogram) cell lines were stained with a PE conjugated anti-human BAFF Ab (clone 1D6) and analyzed for BAFF expression on the cell membrane. A representative histogram is shown here for three independent experiments.

Once demonstrated the expression of membrane-bound BAFF by both murine and human MCs, we moved to the study of the soluble form of this cytokine. With this aim, cell supernatants were collected from both *wt* and *baff*<sup>-/-</sup> MCs which were cultured for 48 h in medium without IL-3; then BAFF concentration was determined through ELISA. Interestingly, resting BMDCs were not able alone to produce soluble BAFF since no differences were observed compared to the knock-out condition (Fig.3.11A). Similarly, the amounts of soluble BAFF released by HMC-1.2 and LAD2 cells were almost undetectable and comparable to the negative control condition, that is HEK 293 cell supernatant (Fig. 3.11B). These results prompted to further investigate the process of BAFF release and assess the relevance of MC-stimulation in this experimental setting. Indeed, several works have shown that BAFF release into the external fluids is stimulus-dependent (Scapini et al., 2008b). Both *wt* and *baff*<sup>-/-</sup> BMDCs were cultured for 48 h in the presence or absence of different

stimuli known to be related to an increase of BAFF production (LPS, IFN- $\gamma$ , LPS+IFN- $\gamma$ ). However, once again, the levels of BAFF detected in cell supernatants did not change compared to the *baff*<sup>-/-</sup> condition, even following cell stimulation (Fig. 3.11C).

All together, these data suggest that membrane-bound but not soluble BAFF is produced by resting MCs, which require a specific, and not yet identified, signal to promote the release of this cytokine.



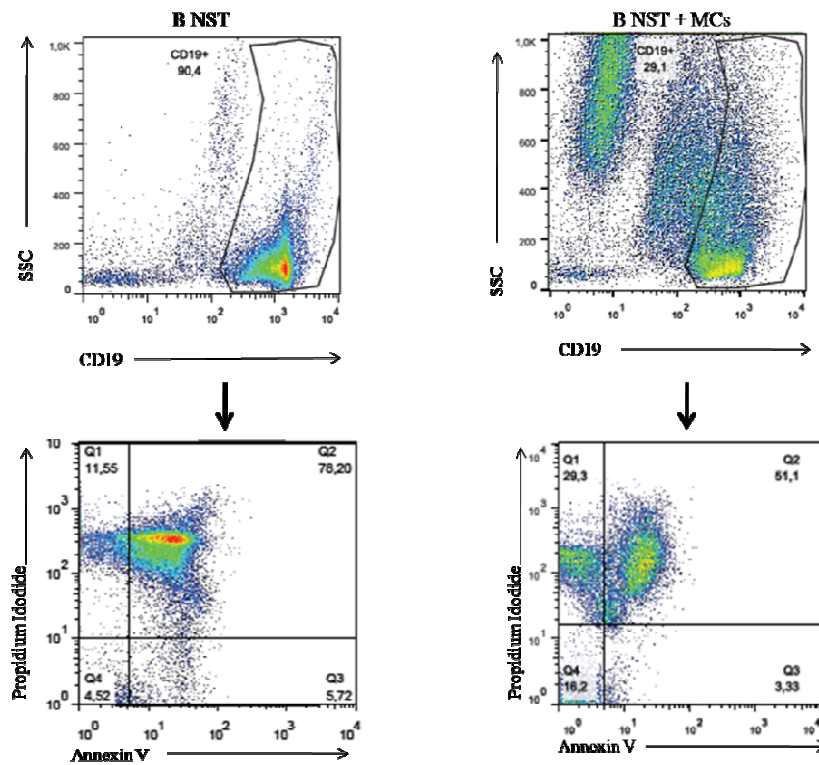
**Figure 3.11. MCs do not produce soluble BAFF.** (A) For measuring secreted BAFF, culture supernatants from wild type (wt) and BAFF-deficient (*baff*<sup>-/-</sup>) BMMCs were harvested after 48 h of culture in medium without IL-3 and BAFF concentration was measured by ELISA. The culture supernatant of LPS-stimulated neutrophils was used as positive control. (B) The soluble form of human BAFF was measured in cell supernatants of HMC-1.2, LAD2, U937 and HEK 293 cells which were cultured for 48 h under basal conditions. (C) The production of soluble BAFF was measured in wt and *baff*<sup>-/-</sup> MCs after stimulation with either LPS, IFN- $\gamma$  or LPS+ IFN- $\gamma$  for 48 h. (A, B, C) All reported results are from a representative experiment.

## **3.2. ROLE OF MC-PRODUCED BAFF IN THE B/MC CROSSTALK**

### **3.2.1. MC-expressed BAFF promotes B cell survival**

Over the last decade, several studies have shown that MCs are important regulators of B cell biology and that they exert their function by producing several cytokines and expressing important co-stimulatory molecules (Merluzzi et al., 2014). After demonstrating BAFF expression in MCs and its production mainly as a cell-surface protein, the next step was to understand the role of this cytokine in the crosstalk between B cells and MCs (B/MC). Since one of the most important roles of BAFF is to enhance B cell survival (Mackay and Browning, 2002), our first aim was to assess the contribution of BAFF to MC-induced B cell survival.

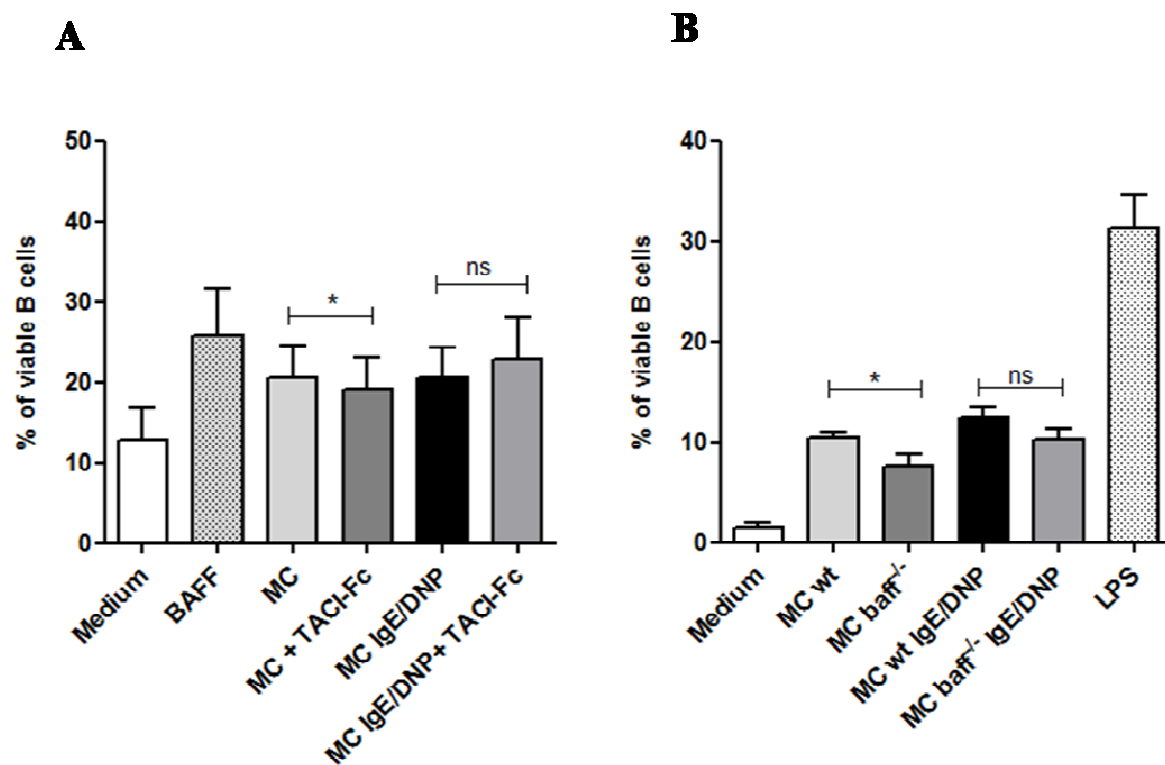
To test the effect of MC-expressed BAFF on B cell viability, freshly purified splenic B cells were cultured alone or with either unstimulated or IgE-Ag-stimulated MCs, in a 1:1 ratio. To block the possible interaction between BAFF on MC-surface and its receptor on B cells, the B/MC co-culture condition was set up in the presence or absence of a recombinant mouse TACI-Fc chimera. Since BAFF leads to the survival of B cells (Mackay et al., 2003), BAFF-stimulated B cells were used as positive control of the experiment. After 48 h of co-culture, cells from each condition were collected, washed with PBS and stained with an anti-CD19 mAb in order to discriminate B cells from MCs. Finally, staining with annexin V and propidium iodide was required to discriminate viable from necrotic or apoptotic B cells. Figure 3.12 shows a representative analysis of the flow cytometry data and the gating strategy performed to exclude the MC from the analysis of B cell viability.



**Figure 3.12. Gating strategy and flow cytometry analysis for the identification of viable B cells in the B/MC co-culture.** Using the CD19 vs SSC plot (left panel) it is possible to select only the B cell fraction and exclude MCs from the analysis. Percentages of necrotic (AnnexinV<sup>neg</sup> Propidium Iodide<sup>pos</sup>), late apoptotic (AnnexinV<sup>pos</sup> Propidium Iodide<sup>pos</sup>), early apoptotic (AnnexinV<sup>pos</sup> Propidium Iodide<sup>neg</sup>) and viable (AnnexinV<sup>neg</sup> Propidium Iodide<sup>neg</sup>) cells were assessed by flow cytometry after cell staining with annexin V and propidium iodide (right panel). Flow cytometry plots from one representative experiment are shown.

As expected, compared to the condition in which B cells were cultured alone, B cell viability increased both in the presence of recombinant murine BAFF and of resting or IgE/Ag activated MCs (Fig. 3.13A). Interestingly, in the presence of TACI-Fc a slight although significant reduction of viable B cells was observed with resting but not IgE/Ag stimulated MCs.(Fig. 3.13A). To further investigate these findings, we used BMBCs derived from *baff*<sup>-/-</sup> mice to set up the B/MC co-culture. As shown in panel B of Fig. 3.13, consistently with the experiment performed using TACI-Fc, a decrease of the percentage of viable cells was observed using BAFF-deficient MCs, reduction that reached statistical significance in the case of resting (30% decrease) but not IgE/Ag (20% decrease) stimulated MCs. Collectively, these data lead to the conclusion that the contribution of BAFF to MC-induced B cell survival is particularly relevant in the case of resting MCs, where this cytokine might act together to

other co-stimulatory molecules to ensure the optimal function of MCs. Conversely, the role of membrane-bound BAFF might become secondary in the case of the co-culture between B cells and IgE/Ag stimulated MCs, a condition in which the action of BAFF is hidden by other cytokines released by activated MCs which are known to be important physiological stimulators of B cell growth and survival.

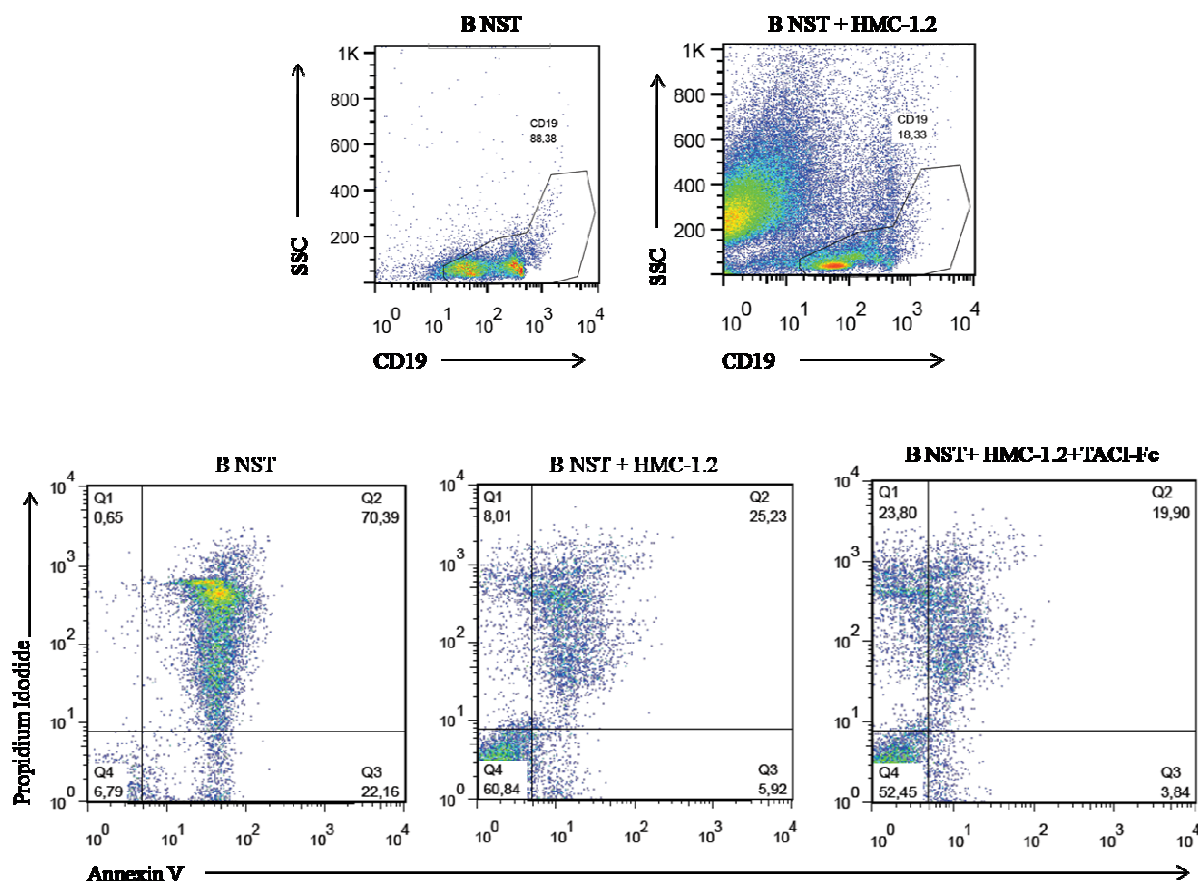


**Figure 3.13. BAFF plays a significant role in B cell survival induced by resting murine MCs.** (A) B cell viability was analyzed through Annexin V/Propidium Iodide assay in B cells cultured for 48 h either alone (Medium) or with non-sensitized MCs (MC) or IgE-sensitized MCs stimulated with DNP (MC IgE/DNP). TACI-Fc (1 $\mu$ g/ml) was added to the co-culture system in order to evaluate the role of BAFF (MC + TACI-Fc; MC IgE/DNP + TACI-Fc). B cells cultured with BAFF (1 $\mu$ g/ml) served as positive control. Bar graphs indicate mean ( $\pm$  SEM) percentages of viable B cells among total B cells from  $n = 6$  independent experiments. (B) The role of BAFF was assessed using *baff*<sup>-/-</sup> MCs and LPS (10 $\mu$ g/ml)-stimulated B cells served as positive control. Bar graphs indicate mean ( $\pm$  SEM) percentages of viable B cells among total B cells from  $n = 4$  independent experiments.

The obtained results prompted us to assess whether MC-expressed BAFF was able to induce B cell survival also in the human system. With this aim, CD19<sup>+</sup>CD21<sup>+</sup>IgM<sup>+</sup> B cells



were isolated from the peripheral blood of healthy donors and cultured with HMC-1.2 cells for 48 h. As shown in Fig. 3.14 the staining and gating strategy is analogous to that developed for the murine system and required the consequential incubation with an a-human CD19 mAb and with annexin V and propidium iodide. Although the experiment was not repeated sufficient times in order to perform a statistical analysis, the data reported in Fig. 3.14 clearly show how HMC-1.2 cells lead to B cell survival, since the percentage of viable cells is increased from about 7% (B NST) to 60% (B NST+HMC-1.2). Remarkably, the percentage of viable cells decreases to about 52% when human TACI-Fc is added to the HMC-1.2/B cell co-culture. This result confirmed the data deriving from the murine system and reinforce the conclusion that BAFF takes part to MC-induced B cell survival.

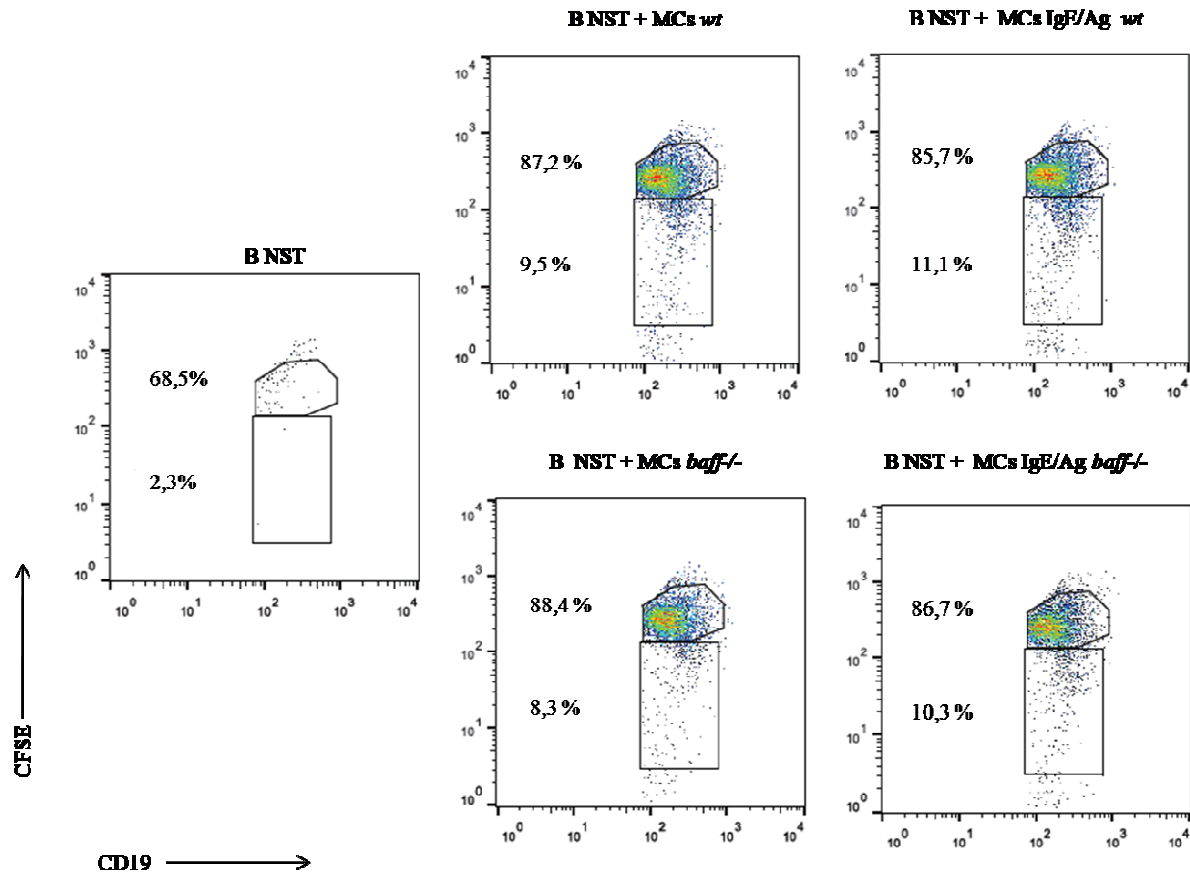


**Figure 3.14.** BAFF is involved in B cell survival induced by HMC-1.2 cells. B cell viability was analyzed through Annexin V/Propidium Iodide assay in CD19<sup>+</sup>CD21<sup>+</sup>IgM<sup>+</sup> cells isolated from peripheral blood and cultured for 48 h either alone (B NST) or with HMC-1.2 cells (B NST + HMC-1.2). Human TACI-Fc (5 µg/ml) was added to the co-culture system (B NST + HMC-1.2 + TACI-Fc) in order to evaluate the role of BAFF. Flow cytometry plots from one representative experiment are shown.

### **3.2.2. MC-expressed BAFF promotes B cell proliferation**

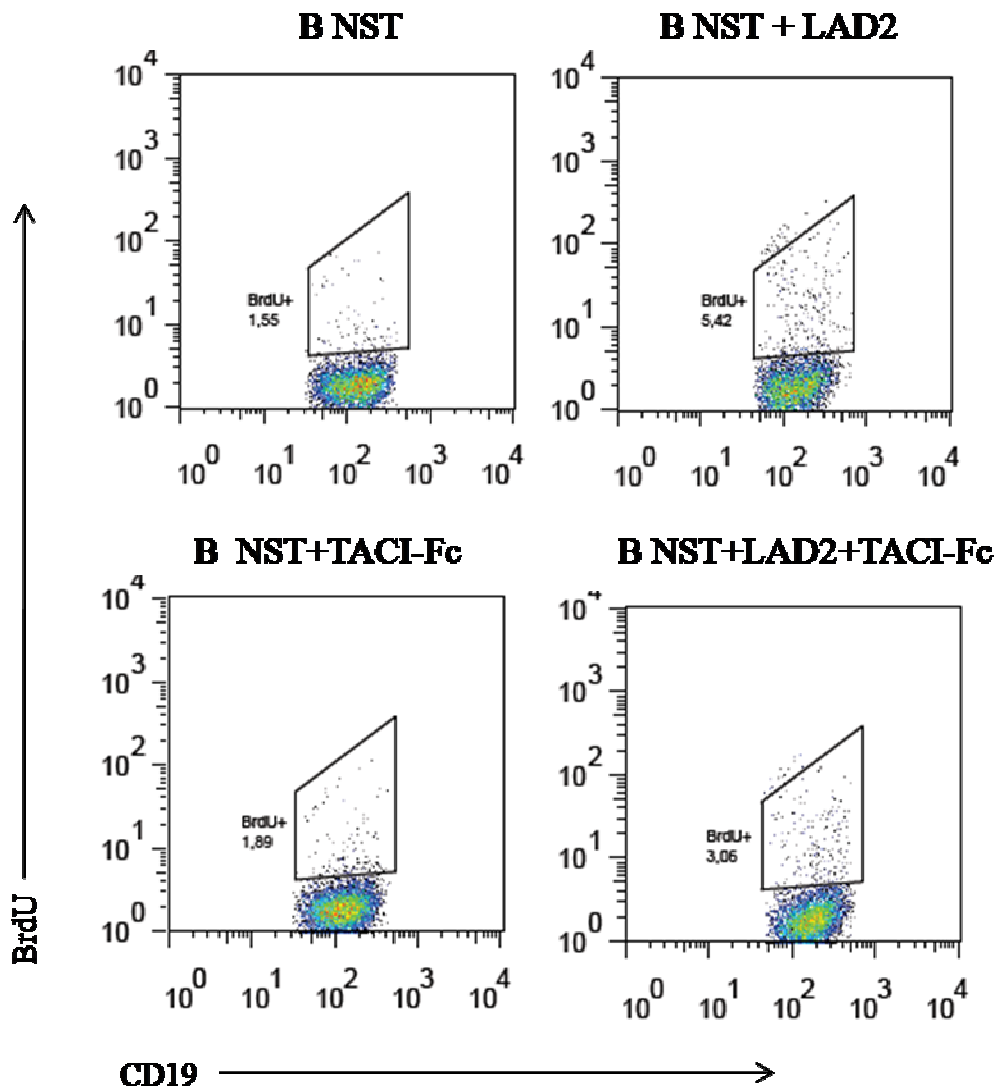
BAFF is best known for its role in the enhancement of B cell maturation and survival, however, the interaction of this cytokine with its receptor was shown to be significant also for B cell proliferation, especially in the case of aggressive B lymphocytes (Liang et al., 2014). MCs were proved to be able to induce a significant increase of naive B cell proliferation, a process dependent on cell-cell contact and MC-derived IL-6 (Merluzzi et al., 2010). Therefore, our next aim was to establish whether MC-expressed BAFF could contribute to the induction of B cell expansion. For this purpose, both for the murine and human system a proliferation assay based on cell labeling respectively with carboxyfluorescein succinimidyl ester (CFSE) and 5-bromo-2-deoxyuridine (BrdU) was set up.

Concerning the murine B cell proliferation assay, B lymphocytes were purified from mouse spleen, stained with CFSE and cultured for 72 h alone or in the presence of either *wt* or BAFF-deficient MCs. Fig. 3.15 shows the flow cytometric analysis of one representative experiment from which it can be noticed that, although an increase in B cell proliferation occurred in the presence of both *wt* and *baff*<sup>-/-</sup> MCs, the frequency of proliferating CD19<sup>+</sup> cells was slightly lower in the co-culture with BAFF-deficient MCs. Indeed, the 2.3% of dividing cells detected among B lymphocytes cultured alone, increased to 9.5% and 8.3% in the co-culture with resting *wt* and BAFF-deficient MCs respectively. Similarly, in the case of IgE/Ag-stimulated MCs, the frequency of proliferating B cells was 11.1% with *wt* MCs and 10.3% with *baff*<sup>-/-</sup> MCs.



**Figure 3.15. BAFF contributes to MC-induced murine B cell proliferation.** CFSE-labeled B cells were cultured for 72 h either alone or in the presence of wt or *baff*<sup>-/-</sup> MCs. Diminished CFSE intensity, indicative of proliferation, was detected in CD19<sup>+</sup> B cells by flow cytometry. CFSE profiles of B cell proliferation in the different conditions are shown for one representative experiment, out of three.

The results obtained in the murine system were further investigated by analyzing what happened when recombinant human TACI-Fc was added to the co-culture system made of CD19<sup>+</sup>CD21<sup>+</sup>IgM<sup>+</sup> primary human B cells and LAD2 MCs. Human B cell proliferation was followed through the BrdU assay, in which only replicating cells incorporate this thymidine analog into nuclear DNA and are detected by flow cytometry. Interestingly, the binding of TACI-Fc to human BAFF on MCs caused a reduction of the percentage of CD19<sup>+</sup>BrdU<sup>+</sup> cells from 5.4% to 3.1%. The observed result was exclusively due to the interference with the signaling pathway induced by MC-expressed BAFF as the same effect was not observed when TACI-Fc was added to the medium of B cells cultured alone (Fig. 3.16). All together, these data suggest that BAFF contributes to MC-driven sustainment of B lymphocytes.



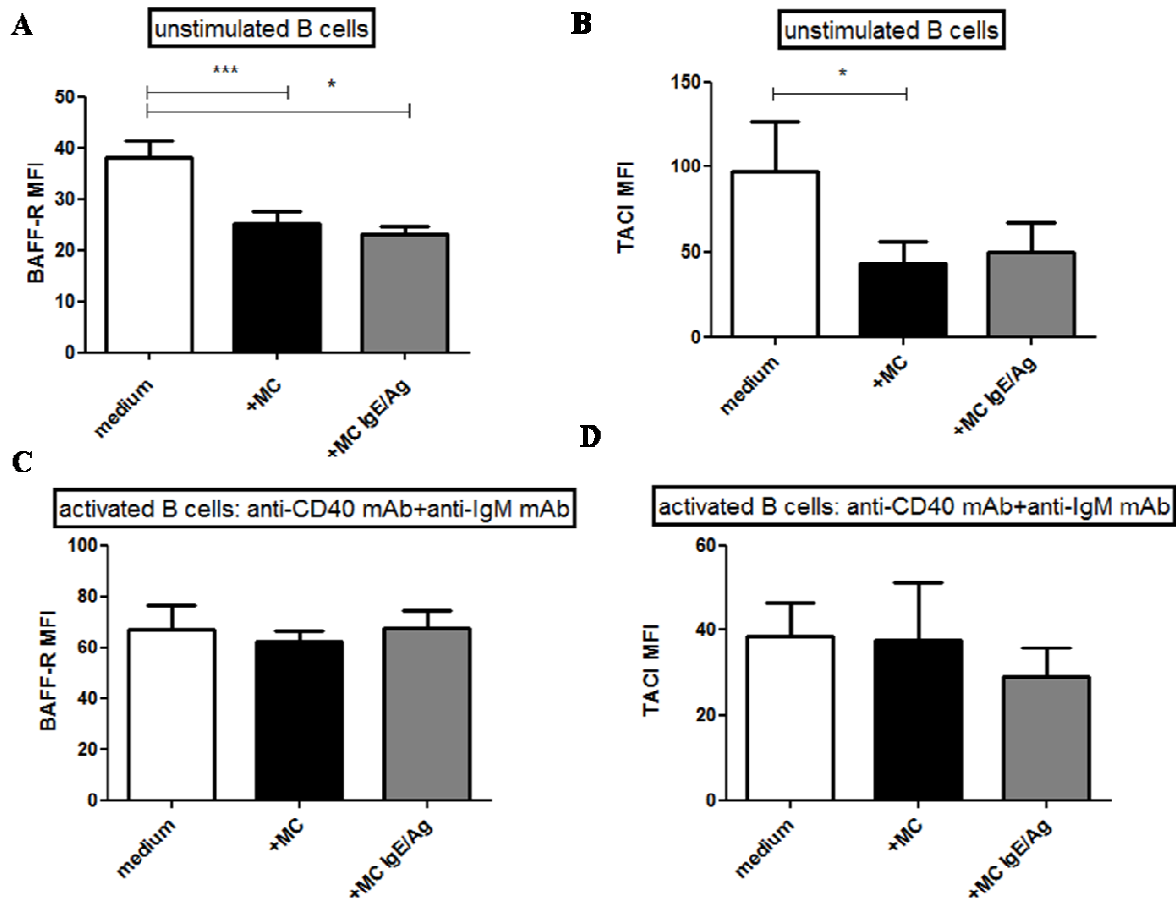
**Figure 3.16. BAFF contributes to MC-induced human B cell proliferation.** Primary human B cells and LAD2 MCs were cultured in a 1:1 ratio for 72 h, in the presence (B NST + LAD2 + TACI-Fc) or absence (B NST + LAD2) of human TACI-Fc (5 $\mu$ g/ml). The frequency of CD19<sup>+</sup> cells that had synthesized DNA, and therefore incorporated BrdU, was determined by immunofluorescent staining with a FITC-conjugated anti-BrdU Ab and consequent flow cytometric analysis. As a control, the same experiment was performed also in B cells cultured alone (B NST). Dot plots for each condition are shown for one representative experiment, out of three.

### 3.2.3. Modulation of BAFF-R and TACI expression by MCs

Given the relevant contribution of MC-expressed BAFF to the sustainment of B lymphocytes, our next aim was to analyze BAFF receptor profile on murine B cells after co-culture with MCs. BAFF can bind to three receptors, BAFF-R, TACI and BCMA, each of which has a diverse specificity for the cytokine and a different expression pattern among all the B cell

subsets (Thompson et al., 2001). In particular, our interest was focused on BAFF-R and TACI since, historically, they are the best defined among the three BAFF receptors (Coquery and Erickson, 2012).

To assess whether MCs could modulate the expression of BAFF-complementary surface molecules, freshly purified splenic B cells were cultured for 48 h with either unstimulated or IgE-Ag-stimulated MCs, in a 1:1 ratio. Consecutively, cell surface expression of TACI and BAFF-R was determined by flow cytometric analyses. Interestingly, a down-regulated expression of both receptors was observed on unstimulated B cells after co-culture with either non-sensitized or IgE-Ag-stimulated MCs (Fig. 3.17A, B). This observation can be explained as the result of an increased rate of BAFF-R and TACI internalization or as a down-modulation of gene expression, both induced by BAFF-binding. However, more detailed studies are required to understand the exact mechanism at the basis of this result. Of note, the reduced levels of BAFF-R and TACI, detected following incubation with MCs, were not observed in the case of B cells activated with purified anti-mouse CD40 and anti-mouse IgM Ab (Fig. 3.17C, D), further supporting the hypothesis that MC-expressed BAFF is relevant in a condition of paucity of B cell survival and activating factors.



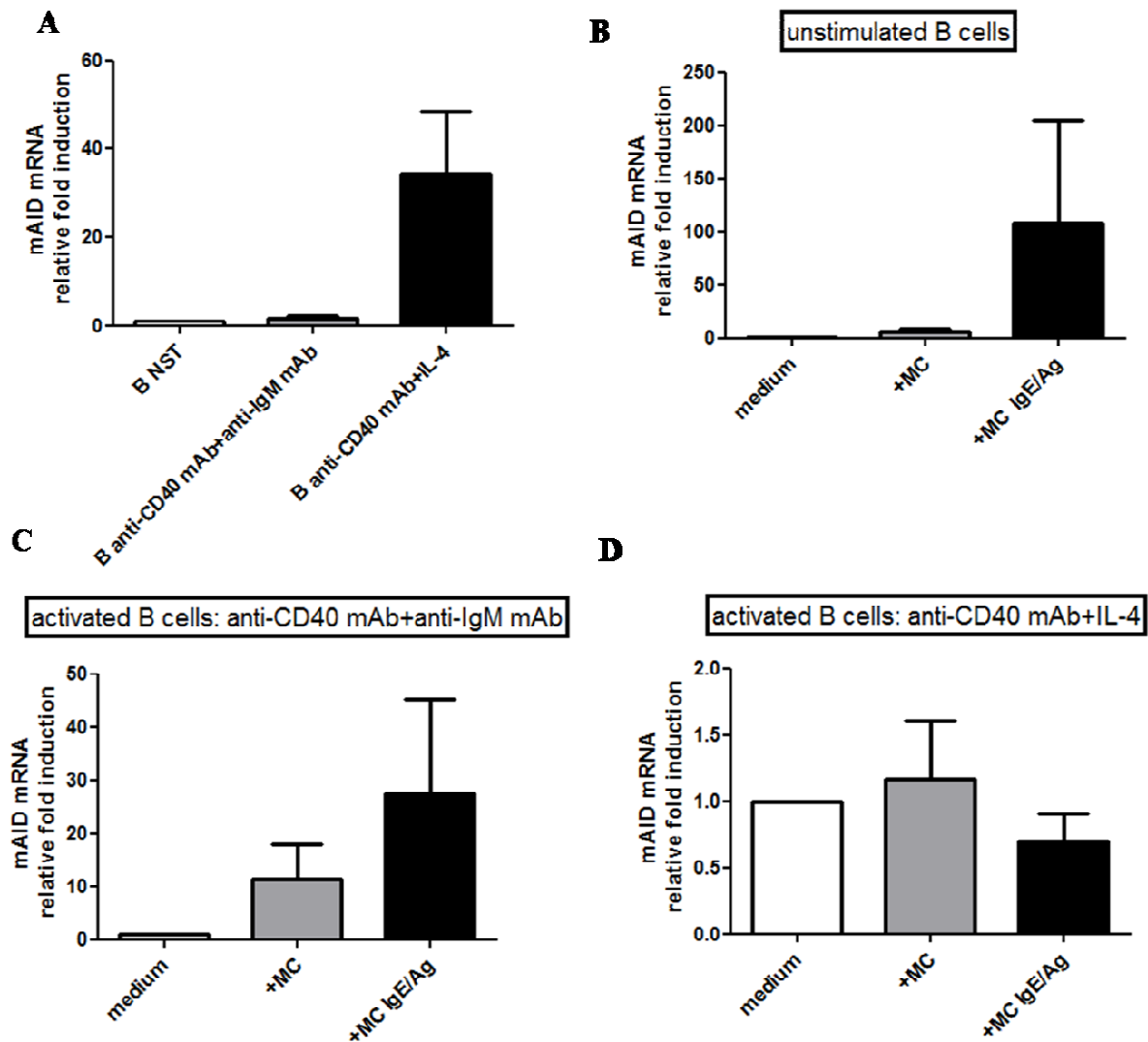
**Figure 3.17. Modulation of BAFF-R and TAC1 expression on B cell surface, after culture with MCs.** (A, B) B cells were cultured either alone (Bnst) or with MCs (B+MC; B+MC IgE/Ag) for 48 h. At the end of incubation, cells were collected and stained with anti-CD19 Ab and anti-BAFF-R or anti-TAC1 Ab. Histograms show either BAFF-R (A) or TAC1 (B) mean fluorescence intensity (MFI) in each condition. Reported results show means ( $\pm$  SEM) from five independent experiments. \*  $p < 0,05$ ; \*\*\*  $p < 0,001$ . (C, D) The same experiment was performed on B cells activated with purified anti-mouse CD40Ab ( $1\mu\text{g/ml}$ ) and anti-mouse IgM Ab ( $0.5\mu\text{g/ml}$ ). Reported results show means ( $\pm$  SEM) from four independent experiments. \*  $p < 0,05$ .

### 3.2.4. MC-expressed BAFF does not affect AID expression in B lymphocytes

Along with the induction of B cell proliferation and survival, MCs were also shown to play a role in the induction of humoral immune responses since they provide important signals that switch Ab production and CSR (Merluzzi et al., 2014). Several reports have demonstrated that MCs support IgE synthesis by B cells through CD40L, IL-4 and IL-13 expression (Gauchat et al., 1993; Pawankar et al., 1997; Ryzhov et al., 2004). Moreover, IgE/Ag activated MCs were also proved to induce IgA surface expression and secretion in activated B cells (Merluzzi et al., 2010). The process of CSR, together with SHM, increases the diversity of Igs and requires

a fundamental enzyme, named AID, which is predominantly expressed in GC B cells (Park, 2012). Among the classic factors known to induce AID expression in B lymphocytes (LPS, IL-4, CD40L), also BAFF and APRIL have been reported (Castigli et al., 2005; Kim et al., 2011; Litinskiy et al., 2002).

All together these evidences prompted us to investigate if MCs could induce AID expression in primary murine B cells and whether membrane-bound BAFF could constitute one of the factors through which MCs could exert this function. Since MCs could either induce the *de novo* synthesis of this enzyme or potentiate an AID-inducing biological context, their role was assessed both in the presence (anti-mouse CD40 Ab plus IL-4) and absence (unstimulated B cells or B cells activated with anti-mouse CD40 Ab plus anti-mouse IgM Ab) of AID-inducing stimuli (Fig. 3.18A). In all cases,  $5 \times 10^6$  B cells were cultured for 96 h either alone or in a 1:1 ratio with resting or IgE/Ag-activated MCs. AID transcripts were measured by qPCR in B cells cultured alone and in B cells which were separated from MCs through a immuno-affinity system, based on the use of magnetic beads conjugated to the anti-CD45R/B220 Ab. Although the differences did not reach statistical significance due to the presence of high variability among the performed experiments, the results presented in Fig. 3.18B and 3.18C clearly show that IgE/Ag-stimulated MCs are able to promote AID expression both in unstimulated B cells and in B cells activated with anti CD40 and anti IgM Abs,. Conversely, when B cells were stimulated with IL-4, MCs did not increase the levels of AID mRNA expression (Fig. 3.18D), suggesting that MCs might provide fundamental signals for CSR and SHM in the lack of optimal AID-inducing stimulation.

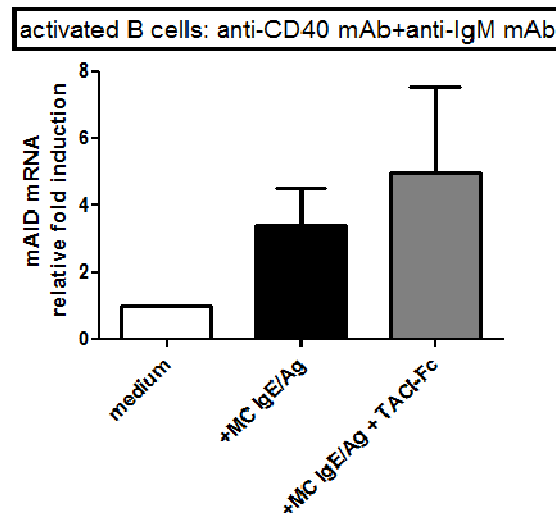


**Figure 3.18. Role of B cell activating stimuli and of MCs in the regulation of AID gene expression.** (A)  $5 \times 10^6$  purified B cells were cultured at  $10^6$ /ml in the absence of stimulation (NST) or in the presence of either agonistic CD40 mAb plus anti-IgM Ab or of agonistic CD40 mAb plus IL-4. Expression of AID was assessed by qPCR after 96 h from the beginning of stimulation. The expression levels are shown as fold induction over unstimulated B cells and the G3PDH transcript levels were used to normalize samples. Reported results show means ( $\pm$  SEM) from two experiments. (B, C, D) Unstimulated B cells (B) or B cells activated with either agonistic CD40 mAb plus anti-IgM Ab (C) or of agonistic CD40 mAb plus IL-4 (D) were cultured at  $10^6$ /ml in the presence or absence of either resting or IgE/Ag-activated MCs. Prior to RNA extraction, MCs and B cells from the co-culture system were separated through a immuno-affinity system based on the use of magnetic beads conjugated to the anti-CD45R/B220 Ab. In all tested conditions, the expression levels are shown relative to the expression level in B cells cultured alone and G3PDH was used to normalize samples. Reported results show means ( $\pm$  SEM) from at least  $n=5$  (B, D) and  $n=3$  (C) independent experiments.

Next, we used a TACI-Fc to test whether BAFF could contribute to MC-driven induction of AID expression. Since our results showed that the MC played a relevant role especially when B cells were activated through CD40 and BCR, the effect of TACI-Fc addition was evaluated in the co-culture between IgE/Ag-activated MCs and B cells stimulated with anti-CD40 Ab



plus anti-IgM Ab. As shown in Fig. 3.19, our results lead to the conclusion that MC-produced BAFF is not involved in AID induction since no reduction in AID mRNA expression was observed in the presence of TACI-Fc.



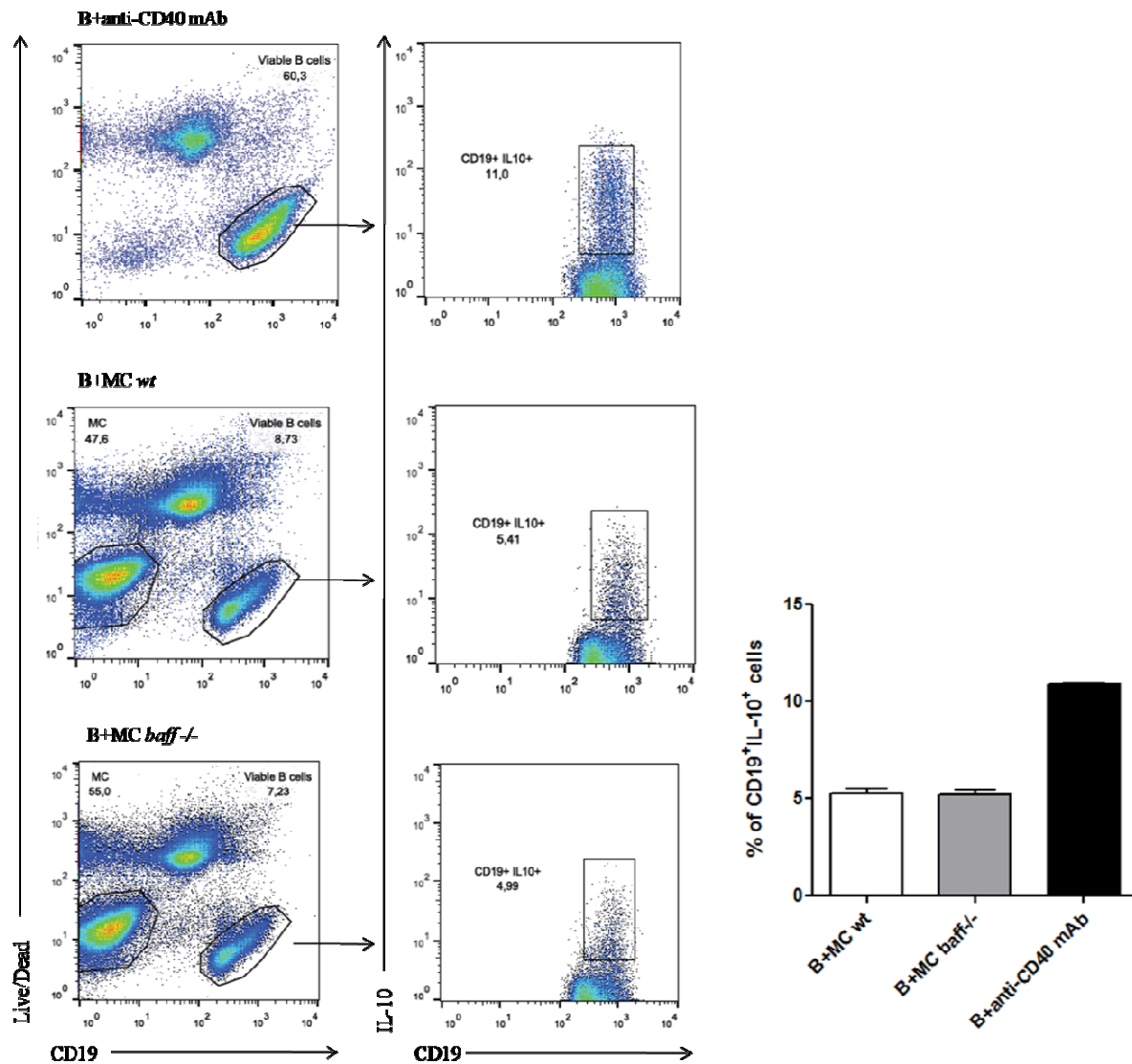
**Figure 3.19. MC-expressed BAFF does not contribute to AID induction in B cells activated through CD40 and BCR.**  $5 \times 10^6$  purified B cells were incubated with anti-CD40 and anti-IgM Abs and cultured for 96 h in the presence or absence of IgE/Ag-activated MCs. The co-culture condition was also performed in the presence of a TACI-Fc. Expression of AID was assessed by qPCR. In all tested conditions the expression levels are shown relative to the expression level in B cells cultured alone. Reported results show means ( $\pm$  SEM) from at least three independent experiments.

### 3.2.5. BAFF is not involved in MC-induced IL-10-competent B cell expansion

In the last years, one of the most important topic discussed among immunologists is the capacity of the immune system to finely regulate, and not only activate, the immune response. Among the cells that play this important role, great interest has been recently devoted to regulatory B cells which were shown to suppress immune responses by means of the production of the anti-inflammatory cytokine IL-10 (Candando et al., 2014; Mauri, 2010). To date it has been widely demonstrate that stimulation through CD40 is essential for the induction of regulatory B cells even if other signaling pathways were proved to play a role. Among all, BAFF was shown to induce MZ B cell differentiation into IL-10-producing B cells and the *in vivo* transfer of BAFF-induced IL-10<sup>+</sup> B cells significantly inhibited the

development of collagen-induced arthritis in mice (Yang et al., 2010a). Interestingly, it has been recently demonstrated that MCs control the expansion and differentiation of IL-10-competent B cells, both *in vitro* and *in vivo*, and that the CD40L/CD40 axis plays a significant role in this important MC-function (Mion et al., 2014a). Thus, as a next step in our investigation of the functions of MC-expressed BAFF in the B/MC crosstalk, we decided to assess whether membrane-bound BAFF could also contribute to MC-driven expansion of IL-10-competent B cells.

Murine *wt* or *baff*<sup>-/-</sup> MCs were cultured together with splenic B cells at a 1:1 ratio for 48 h. 5 h before cell harvesting, a mixture of LPS, PMA, ionomycin and monensin (LPIM) was added to the co-culture to induce cytoplasmic IL-10 production in IL-10-competent B cells and block protein secretion. As shown in Fig. 3.20, the production of BAFF by *wt* MCs does not play a significant role in their ability to induce IL-10-competent B cells since no difference was observed in the percentage of CD19<sup>+</sup>IL-10<sup>+</sup> cells in respect to the *baff*<sup>-/-</sup> condition. A reduction of IL-10-competent B cells was neither observed when blocking BAFF signaling through the addition of murine TACI-Fc to the B/MC co-culture (data not shown). Therefore, this data lead to the conclusion that MC-expressed BAFF does not provide IL-10-competent B cell differentiation signals.



**Figure 3.20.** MC-expressed BAFF does not contribute to MC-driven expansion of IL-10-competent B cells. IL-10-competent B cells were analyzed among B cells stimulated with anti-CD40 Ab (positive control) or cultured for 48 h with either wt or baff<sup>-/-</sup> MCs. In all conditions, LPIM was added for the last 5 h of culture. Dot plots for one representative experiment are shown. CD19 versus Live/Dead plots allow to identify viable B cells and exclude both MCs, which are negative for CD19 staining, and dead cells that are positive for Live/Dead staining. Only viable B cells were analyzed for IL-10 staining, and a perfectly matched isotype control was used to discriminate IL-10<sup>+</sup> from IL-10<sup>-</sup> B cells (not shown). Bar graphs indicate mean ( $\pm$ SEM) percentages of IL-10<sup>+</sup> cells among total B cells ( $n = 2$ ).

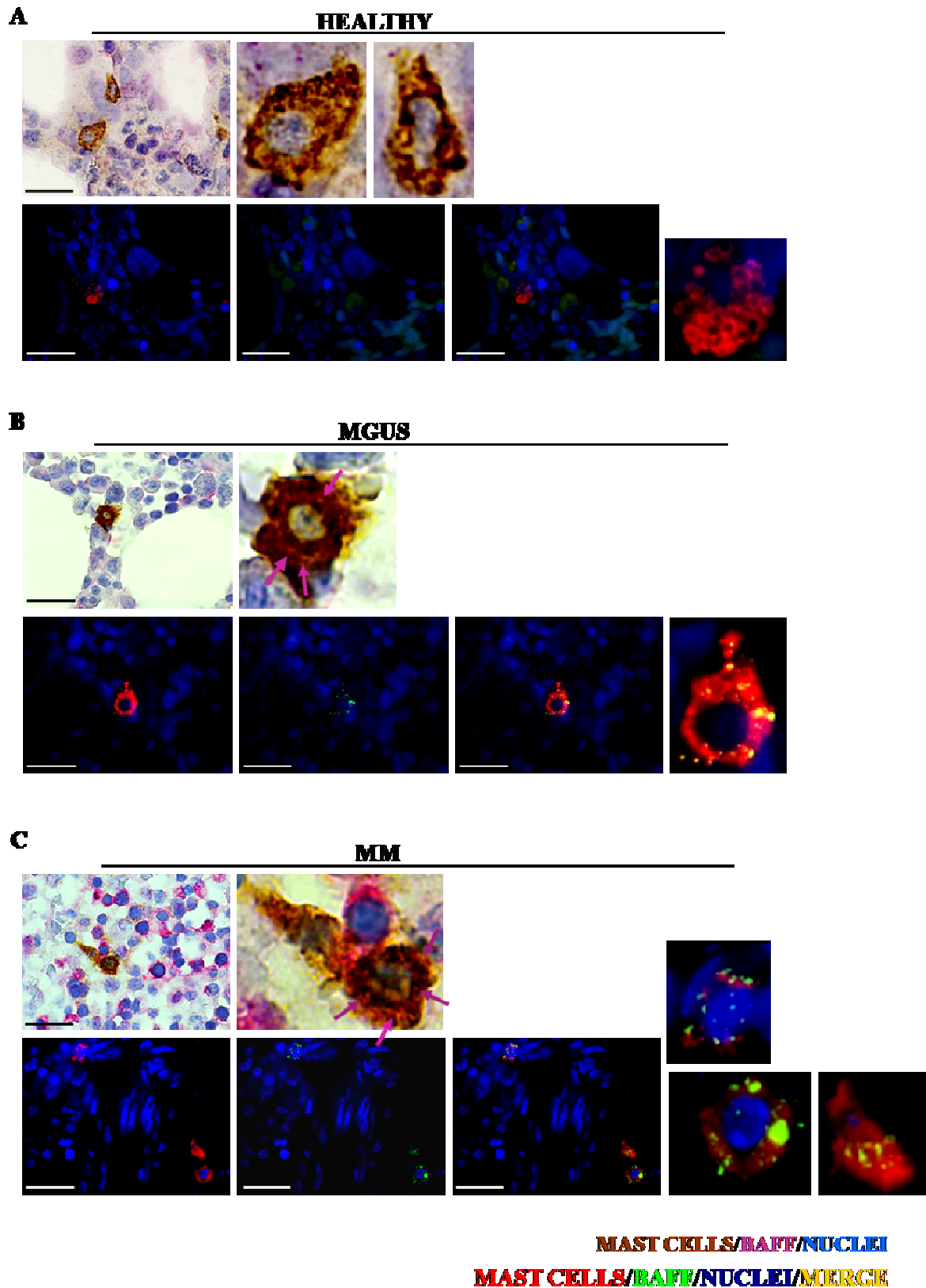
### 3.3. MC-DERIVED BAFF AND MULTIPLE MYELOMA

#### 3.3.1. MCs of MM patients present strong BAFF expression

For a long time the study of BAFF has been almost exclusively related to the field of autoimmunity. However, the system made up of BAFF and its receptors is emerging as a

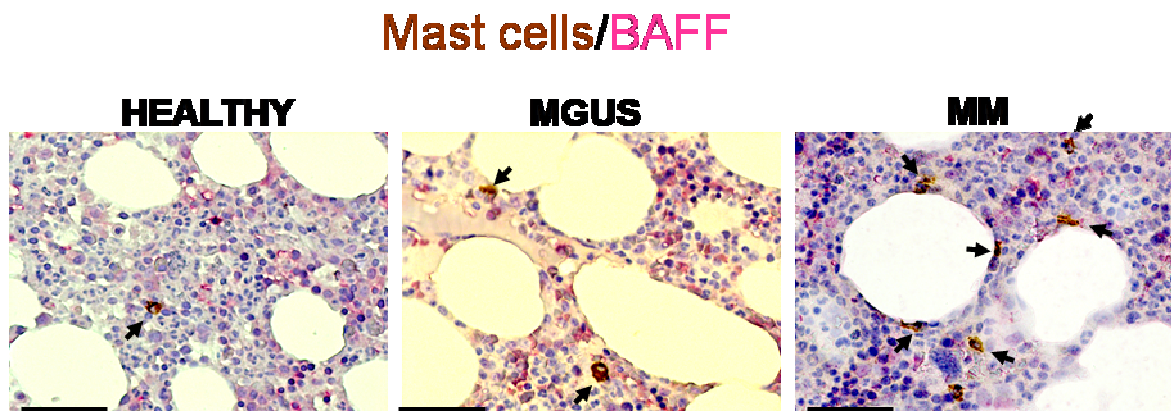
noteworthy component in several B-cell malignancies, where it has been shown to play a relevant role for the survival of the transformed B cell (Shivakumar and Ansell, 2006; Vincent et al., 2013). Depending on the specific B-cell neoplasia in analysis, BAFF can be expressed by tumor associated cells (paracrine signaling), by the malignant B cell itself (autocrine signaling) or by both these components of the tumor microenvironment. Stromal cell-production of BAFF was shown to play a key role in the support of mantle cell lymphoma (Medina et al., 2012), while malignant Hodgkin and Reed-Sternberg cells receive survival and proliferation signals from the binding of BAFF produced by both the malignant cells and by the reactive myeloid cells infiltrating the tumor (Chiu et al., 2007).

In light of all these evidences, we decided to further corroborate our *in vitro* findings relatively to BAFF production by MCs, by analyzing the *in vivo* context of a B-cell neoplasia. Among all, we decided to focus on MM, since a relevant role in the pathophysiology and progression of this disease has been described for both MCs (Ria et al., 2011; Ribatti et al., 1999, 2004) and BAFF (Fragioudaki et al., 2012; Moreaux et al., 2004). With this aim, and in collaboration with the group of Professor Vacca at the University of Bari, we analyzed the expression of BAFF on MCs through confocal microscopy and immunohistochemistry analysis of bone marrow biopsies of healthy controls and of MGUS and MM patients. As shown in panel A of Fig. 3.21, among the rare MCs found in the bone marrow sections of healthy controls, none was found to be positively stained for BAFF. Conversely, tryptase-positive BAFF-producing cells were detected in sample of MGUS patients (Fig. 3.21B) and, to a greater extent in MM patients (Fig. 3.21C).



**Figure 3.21.** BAFF expression by MCs of healthy, MGUS and MM bone marrow biopsies. Immunohistochemistry (top panels) and immunofluorescence (bottom panels) for MC tryptase (brown in IHC; red in IF), BAFF (pink in IHC; green in IF) and nuclei (blue) on bone marrow biopsies from healthy subjects (A) and from patients with MGUS (B) or MM (C). Data are representative of bone marrow biopsies from three different healthy subjects, MGUS and MM patients. Original magnification and scale bars respectively = x100, 20 $\mu$ m.

The immunohistochemical images at higher magnification shown in Fig. 3.22 allow to better appreciate the correlation between the number of MCs, the degree of BAFF staining and the progression of the disease. Indeed, though it needs to be underlined that a certain degree of variability is present among both healthy subjects and patients, the representative images clearly show how a higher number of BAFF<sup>+</sup> MCs can be found in bone marrow biopsies of MM patients compared to healthy and MGUS conditions.



**Figure 3.22.** *Correlation between BAFF-positive MCs and the progression of the disease. Representative tryptase (brown, MCs) and BAFF (pink) staining of sections from bone marrow biopsies of healthy controls and of MGUS and MM patients. Arrows indicate BAFF-positive MCs. Original magnification: 40X. Scale bar: 50  $\mu$ m.*

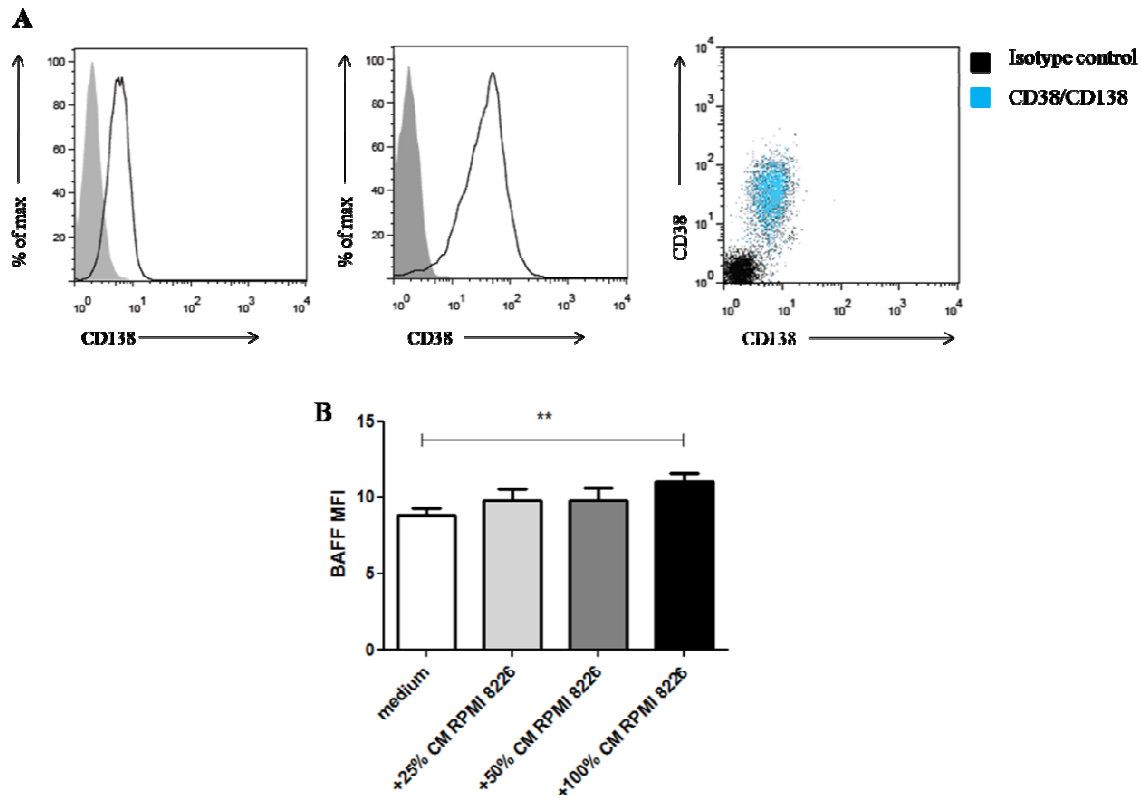
All together, these analyses indicate that MCs can produce BAFF *in vivo*, and that the expression of this cytokine might be influenced by the tumor microenvironment. Moreover, given the importance of BAFF in B-cell survival, these results suggest that the role of the MC in MM might go beyond the promotion of bone marrow angiogenesis and could be extended to a contribution in the maintenance and/or growth of the malignant B-cell clone, which would obviously lead to the exacerbation of the disease.

### **3.3.2. BAFF expression is up-regulated by the conditioned medium of myeloma cells**

In the context of MM, it has been shown the existence of an autocrine survival loop in which myeloma cells themselves produce BAFF and APRIL to support their growth and survival (Moreaux et al., 2004). The observed correlation between the number of BAFF-positive MCs and the progression of the disease, lead us to investigate whether signals released by myeloma cells could modulate BAFF expression on MCs.

Given the technical difficulties at the base of cell isolation from bone marrow aspirates, the human MM cell line RPMI 8226 was employed to this end. RPMI 8226 cells were first checked for the expression of both the CD38 and CD138 cell surface markers (Fig. 3.23A), which characterize the phenotypic profile of primary myeloma cells (Paíno et al., 2014). Myeloma cells were then cultured for 48 h and cell supernatant was collected and used, in three different proportions (pure or diluted 1:2 or 1:4 in standard culture medium) to stimulate HMC-1.2 cells. After 24 h of culture, HMC-1.2 cells were collected and assessed for the expression of membrane-bound BAFF by flow cytometry. Interestingly, when human MCs were cultured with pure conditioned media from RPMI 8226 cells, a significant reduction of BAFF expression was observed relative to HMC-1.2 cells grown in standard culture medium (Fig. 3.23B).

The obtained result suggests that soluble mediators released by RPMI 8226 cells can up-regulate the expression of the membrane-bound form of BAFF in human MCs. At this point, the next step would have been to assess which of the various factors produced by myeloma cells could be responsible for this effect. However, given that these factors are numerous and different, this step requires a careful analysis of the literature in order to identify the best candidate, and it therefore represents one of the future goals of this project.



**Figure 3.23. Membrane-bound BAFF expression on HMC-1.2 is affected by soluble mediators released by RPMI 8226 cells.** (A) Histogram and dot plots showing the expression of CD38 and CD138 on RPMI 8226 cells. (B) HMC-1.2 cells were cultured for 24 h with standard culture medium (medium) or in the presence of conditioned medium (CM) of RPMI8226 cells which was used pure (100% CM RPMI) or diluted 1:2 (50% CM RPMI) or 1:4 with standard culture medium (25% CM RPMI). At the end of incubation, membrane-bound BAFF expression was assessed on HMC-1.2 cells by flow cytometry. Histogram graph show the mean fluorescence intensity (MFI) of BAFF for each condition. Reported results show means ( $\pm$  SEM) from three independent experiments. \*  $p < 0,05$ .

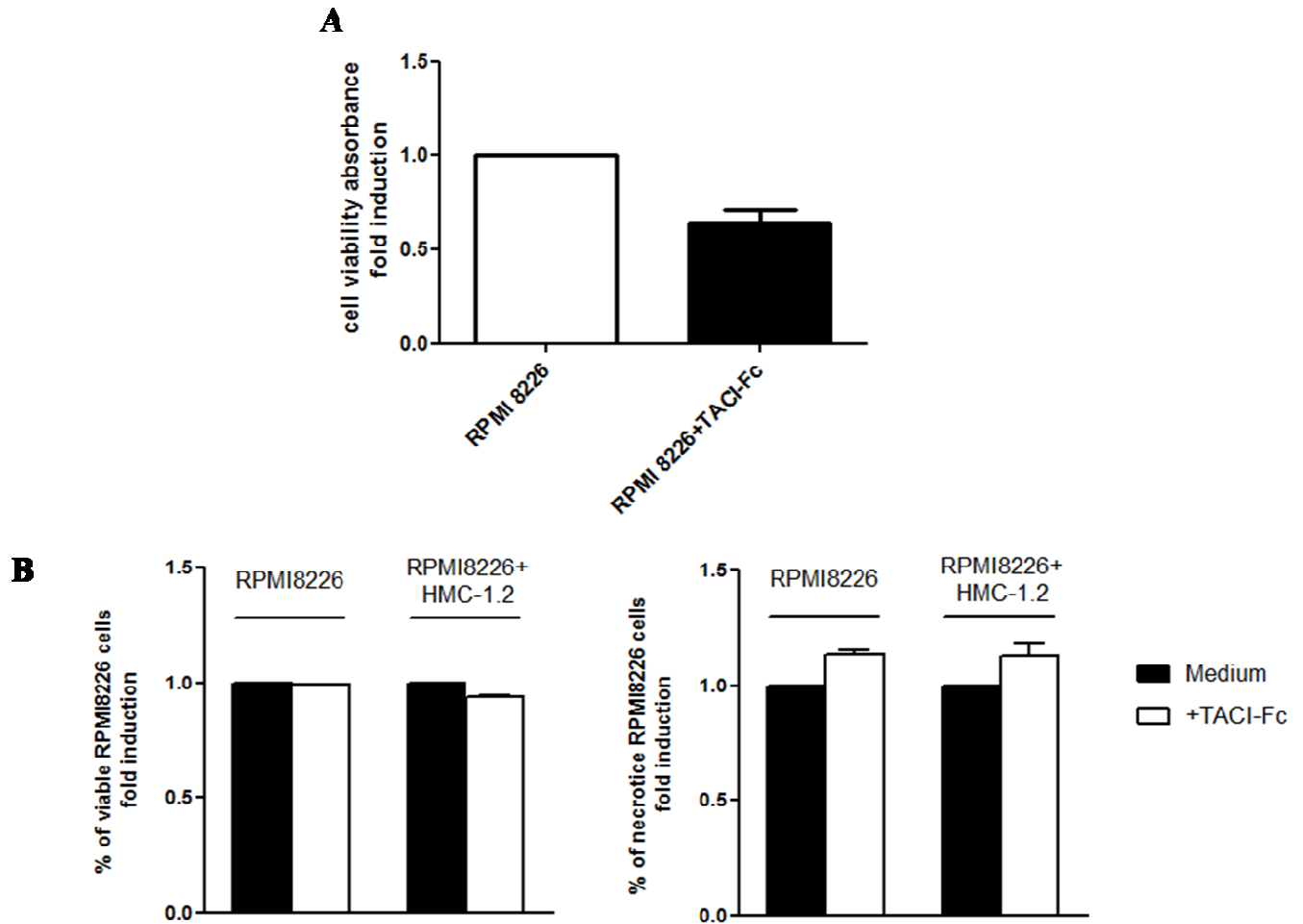
### 3.3.3. Role of MC-derived BAFF in myeloma cell survival

The evidence that BAFF-positive MCs are present in bone marrow biopsies of MM patients together with our finding that MC-expressed BAFF contributes to MC-driven survival of normal B cells, lead us to assess whether an uncontrolled version of this mechanism could contribute to the maintenance of the malignant B cell clone, thus exacerbating or sustaining the disease.

With this aim, we set up a culture system in which RPMI 8226 myeloma cells were seeded alone or with HMC-1.2 cells and cultured in the presence or absence of the soluble TACI-Fc



decoy receptor. 48 h later, the viability of RPMI 8226 cells was assessed in the different conditions. It must be kept in mind that, as already reported by Moreaux and coworkers (Moreaux et al., 2004), TACI-Fc blocks the autonomous growth of RPMI 8226 cells (Fig. 3.24A), complicating the investigation of the role of BAFF and APRIL in the co-culture system made of the two cell lines. As shown in panel B of Fig. 3.24, in our preliminary results, the effect of the addition of TACI-Fc is almost the same in the conditions in which RPMI cells are cultured alone or with HMC-1.2, even if a slight difference is observed among viable cells. An improved tuning of the experimental set-up together with a greater number of experiments are required in order to better define the role of MCs in the maintenance of the malignant B cell clone in MM.



**Figure 3.24.** Role of BAFF in the growth and survival of RPMI 8226 grown alone or with HMC-1.2 cells. (A) Cell viability measured with MTT assay (fold absorbance compared to RPMI 8226 untreated cells). RPMI 8226 were cultured for 72 h with medium and with medium plus TACI-Fc. (B) The percentage of viable and necrotic RPMI 8226 cells was analyzed through Annexin V/Propidium Iodide assay after 48 h of culture with or without HMC-1.2 cells and in the presence (+TACI-Fc) or absence (medium) of the human TACI-Fc decoy receptor. Staining with anti-CD38 Ab was necessary to distinguish RPMI 8226 from HMC-1.2 cells. Results are shown as fold induction over the “medium” condition and are the means of two independent experiments.

## 4. CONCLUSIONS

The immune system is composed of multiple cell types, which together improve the resistance of the organism against infections. The unfolding of a successful host response ensuring effective protection against pathogens requires an appropriate coordination of the different players of the immune system. In this context, MCs are well placed in a strategic location at the host-environment interface, where they serve as immune sentinel cells that respond directly to pathogens and send signals to other tissues to modulate both the innate and adaptive immune response. Indeed, MCs can be detected in serosal cavities and immediately beneath epithelial surfaces, as well as near blood vessels. This peculiar MC-function is due to the expression of an array of adhesion and immune receptors that may assist in the recognition of invading pathogens and in the sampling and integration of different stimuli (Frossi et al., 2004; Metz et al., 2008). Interestingly, in the last few years it has been shown that MCs can exert a homeostatic role on the control of the development, tissue homing and activation of immune and non-immune cell populations independently from the infectious stimuli or MC activation too. Activation and/or suppression of innate and adaptive immune cells depend on cell-cell interactions and on the cytokines released by MCs (Gri et al., 2012).

The present thesis involves studies on the crosstalk between MCs and B cells and describes the contribution of MC-produced BAFF on this axis. In the laboratory in which this work of thesis was performed, it was demonstrated that resting MCs (and to lesser extent the activated MCs too) deliver helper signals to B cells via both direct and indirect mechanisms. In fact, MCs promote both survival and activation of naive B cells as well as proliferation and further plasma cell differentiation of activated B cells through cell-cell contact and the production of soluble factors (Merluzzi et al., 2010; Mion et al., 2014a). In our effort to define soluble and membrane-bound molecules involved in this process, we found that a fundamental role is

played by the CD40:CD40L axis and by IL-6. However, different signals are able to sustain the B cell proliferation and differentiation in a TI manner. In fact, TI Ab responses usually unfold at the mucosal interface or in the splenic MZ and generate polyspecific and low-affinity Abs through a TI pathway involving the interaction of B cells with DCs, macrophages, and granulocytes (Puga et al., 2012). These innate immune cells deliver Ab-inducing signals via BAFF and APRIL (He et al., 2010; Puga et al., 2012). However, considering the role of MC in TI B cell activation, we studied if BAFF could be a cytokine involved in the MC/B cell axis.

We found that the murine MC line MC/9, BMDC and the human MC lines HMC-1.2 and LAD2 constitutively expressed BAFF mRNA, even if at lower levels than in the positive controls, the macrophage-like murine RAW 264.7 and human U937. Moreover, BAFF protein was detected bound at cell membrane, and in cytoplasmic stores, but was not released under the investigated conditions. Additionally, IgE/Ag-, IFN- $\gamma$ -, and LPS-activated MCs do not show a modulation of BAFF gene expression, both in the murine and human system. It has been shown that *in vivo* there is a complex regulation of the stored, membrane-bound and released form of BAFF which could, probably, not be reproduced in our *in vitro* conditions. Innate immune cells, DCs, macrophages and granulocytes, deliver Ab-inducing signals via the CD40L-like cytokine BAFF, and can also potentiate BAFF activity to deliver TI signals through other members of the same family, such as APRIL (Mackay et al., 2007a). In this light, we also analyzed APRIL gene expression in murine MCs. Surprisingly, we found that both LPS-activated BMDCs and MC/9 showed a decreased APRIL mRNA expression but an increase of the same cytokine mRNA was detected in IgE/Ag-stimulated MC/9.

Moving to the protein level, it is worth to note that the analysis of BAFF protein is influenced by the detection system and by the anti-BAFF Abs used in the assay. Indeed, Schneider and co-workers, in a comment to Chu et al paper (Chu et al., 2009), which described the aberrant production of BAFF by over-activated B cells in patients with SLE,

underlined that the work overestimated the quantity of BAFF and this was dependent on the used mAb and recognized BAFF epitopes (Schneider and Huard, 2010). Taking advantage of these studies, we investigated BAFF expression using multiple complementary techniques. We found membrane-bound BAFF expression by murine and human cells using cytofluorimetric analysis. Additionally, confocal experiments confirmed that BAFF protein is expressed on MC-membrane, but is stored intracellularly too. For long time, soluble BAFF has been considered the predominant form of the cytokine but recently, it has been shown that a non-cleavable membrane-bound form of BAFF was at least 50-fold more active than soluble BAFF at delivering signals to responder cells (Bossen et al., 2008). This data has been recently stressed by Kikly's group (Manetta et al., 2014) and suggests that BAFF behave like a co-stimulatory molecule which contributes to the interaction between different immune cells, leading to strong signals of survival and proliferation. Newsworthy, in our analysis of membrane-bound BAFF among different MC cultures, we noticed that, similarly to CD40L (Merluzzi et al., 2014), the expression of BAFF differs with the differentiation stage and culture age of MC, heterogeneity of precursors etc. This underlines the complexity of the BAFF system and the fine modulation that could be dependent on functional requests coming from the microenvironment, elaborated by MCs and transduced to the adaptive immune system through the modulation of co-stimulatory molecules. In our system we were not able to detect BAFF in the supernatant of both human and murine MCs. We will investigate whether MCs have the ability to cleave the membrane-bound form of BAFF or if the expression of exclusively mBAFF is a peculiarity of MCs and of the MC/B cell crosstalk.

In order to understand the role of mBAFF in the MC/B cell interaction, we have first investigated, both in murine and human models, the survival of B cells co-cultured with MCs using a TACI-Fc molecule to block BAFF activity. We have demonstrated that BAFF antagonist induce a reduction of viable B cells, highlighting the role of this cytokine as a survival factor. However, it is important to note that human MCs express the membrane-

bound form of APRIL and the TACI-Fc functionally blocks APRIL activity too (Ho et al., 2008). In the next future, it is our aim to investigate the different contribution of APRIL and BAFF in MC/B cell interaction. However, in the murine system, the obtained results were validated using MCs differentiated from the bone marrow of *baff*<sup>-/-</sup> mice..

BAFF plays a critical role in B cell survival and immune responses by binding to one of its three receptors: BAFF-R, TACI and BCMA (Zhang et al., 2005b). Using specific Abs, we have investigated the expression of BAFF-R and TACI on the surface of B cells co-cultured with MCs and we observed that there is a decrease of their expression on resting B cells. Interestingly, the reduced levels of BAFF-R and TACI were not observed in the case of B cells activated with anti-mouse CD40 mAb plus anti-mouse IgM Ab. This can support the hypothesis that MC-expressed BAFF is relevant in a condition of poorness of B cell survival and activating factors.

Since that our laboratory has been demonstrated that MC enhance B cells proliferation, leads B cells survival and drive their differentiation towards IgA secreting plasma cells (Merluzzi et al., 2010), in order to understand if BAFF on MCs plays a role in the induction of IgA switching on B cells, we have investigated if in B cells cultured with MCs there is an increase of AID expression. We have found that MCs induce AID transcription both in resting B cells and in B cells activated with anti-mouse CD40 mAb plus anti-mouse IgM Ab. However, *baff*<sup>-/-</sup> MCs did not affect this induction.

To assess whether the MC affect the activity of all B cells or of a peculiar subpopulation, we also analyzed the effect of BAFF on MC-driven expansion of IL-10-competent B cells (Mion et al., 2014a), but our results did not show a significant effect. Indeed, the percentage of CD19<sup>+</sup>IL-10<sup>+</sup> cells detected in the MC/B cell co-culture system did not change in the presence or absence of MC-produced BAFF.

Beside its role in the physiological context, BAFF protects myeloma cells from apoptosis and sustain the survival of neoplastic B cells through the interaction with its three receptors

expressed on myeloma cell surface (Sun et al., 2008). In collaboration with Professor A. Vacca at University of Bari, we have analyzed MM sections and we found BAFF<sup>+</sup> MCs infiltrating the bone marrow. The number of MCs positively stained for mBAFF was decreased in bone marrows derived by MGUS patients and no MCs were detected in those of healthy controls. For the first time, we have found that MCs can be the source of mBAFF in the bone marrow of MM patients and probably contribute to the survival of neoplastic B cells in the bone marrow niches. In *in vitro* experiments using the conditioned media of the human myeloma cell line RPMI 8226 we found that the HMC-1.2 human MC line upregulated mBAFF expression. These preliminary results indicate a positive loop between MCs and myeloma cells in which soluble factors from myeloma cells induce BAFF expression on MCs. The expressed cytokine could then contribute to the formation of a favoring microenvironment for myeloma cells. Further investigations will help to define molecular targets that can be used to disrupt this important survival axis in MM.

## **5. MATERIALS AND METHODS**

### **5.1. Solutions and culture media**

- **Culture medium for BMDCs**

RPMI 1640 (Euroclone)

20% FBS (Fetal Bovine Serum) (Sigma Aldrich)

20 mM Hepes (Euroclone)

2 mM L-glutamine (Euroclone)

1 mM sodium pyruvate (Euroclone)

1X non-essential amino acids (from 100X mix, Euroclone)

antibiotics (100 U/ml penicillin and 100 µg/ml streptomycin) (Euroclone)

50 mM β-mercaptoethanol (Sigma Aldrich)

20 ng/ml IL-3 (PeproTech)

20 ng/ml SCF (PeproTech)

- **Culture medium for B cells and MC/B cell co-cultures**

RPMI 1640 (Euroclone)

10% FBS (Sigma Aldrich)

20 mM Hepes (Euroclone)



2 mM L-glutamine (Euroclone)

1 mM sodium pyruvate (Euroclone)

1X non-essential amino acids (from 100X mix, Euroclone)

antibiotics (100 U/ml penicillin and 100 µg/ml streptomycin) (Euroclone)

50 mM β-mercaptoethanol (Sigma Aldrich)

- **Culture medium for the cell lines HMC-1.2, U937, A20**

RPMI 1640 (Euroclone)

10% FBS (Sigma Aldrich)

20 mM Hepes (Euroclone)

2 mM L-glutamine (Euroclone)

antibiotics (100 U/ml penicillin and 100 µg/ml streptomycin) (Euroclone)

- **Culture medium for the murine cell line MC/9**

Dulbecco's modified Eagle's medium: DMEM (Euroclone)

10 % FBS (Sigma Aldrich)

2 mM L-glutamine (Euroclone)

antibiotics (100 U/ml penicillin and 100 µg/ml streptomycin) (Euroclone)

20 mM Hepes (Euroclone)

2 mM L-glutamine (Euroclone)

1 mM sodium pyruvate (Euroclone)

1X non-essential amino acids (from 100X mix, Euroclone)

20 ng/ml IL-3 (PeproTech)

- **Culture medium for the human cell line LAD2**

StemPro-34 (Invitrogen, Carlsbad, CA)

2mM glutamine (Euroclone)

100 ng/ml human SCF (PeproTech)

- **Culture medium for the cell lines RAW 264.7 and HEK 293**

Dulbecco's modified Eagle's medium: DMEM (Euroclone)

10% FBS (Sigma Aldrich)

2 mM L-glutamine (Euroclone)

antibiotics (100 U/ml penicillin and 100 µg/ml streptomycin) (Euroclone)

- **Phosphate Buffered Saline (PBS)**

137 mM NaCl (Sigma Aldrich)

27 mM KCl (Sigma Aldrich)

4.3 mM Na<sub>2</sub>HPO<sub>4</sub> (Sigma Aldrich)

1.4 mM KH<sub>2</sub>PO<sub>4</sub> (Sigma Aldrich)

pH 7.4

- **Tyrode's buffer**

135 mM NaCl (Sigma Aldrich)

5 mM KCl (Sigma Aldrich)

1 mM MgCl<sub>2</sub> (Sigma Aldrich)

1.8 mM CaCl<sub>2</sub> (Sigma Aldrich)

5.6 mM Glucose (Sigma Aldrich)

20 mM Hepes (pH 7,4) (Sigma Aldrich)

- **MIN buffer**

PBS pH 7.4

2 mM EDTA (Sigma Aldrich)

0.5% BSA (Sigma Aldrich)

- **TAE buffer (10x)**

48.5 g Tris 2 mM EDTA (Sigma Aldrich)

11.4 mL glacial acetic acid (Sigma Aldrich)

20 mL 0.5M EDTA (pH 8.0) (Sigma Aldrich)

- **STAINING BUFFER**

DPBS 1X

Sodio azide 0,09% (Sigma Aldrich)

FBS 3% (Sigma Aldrich)

## **5.2. Mice and cell lines**

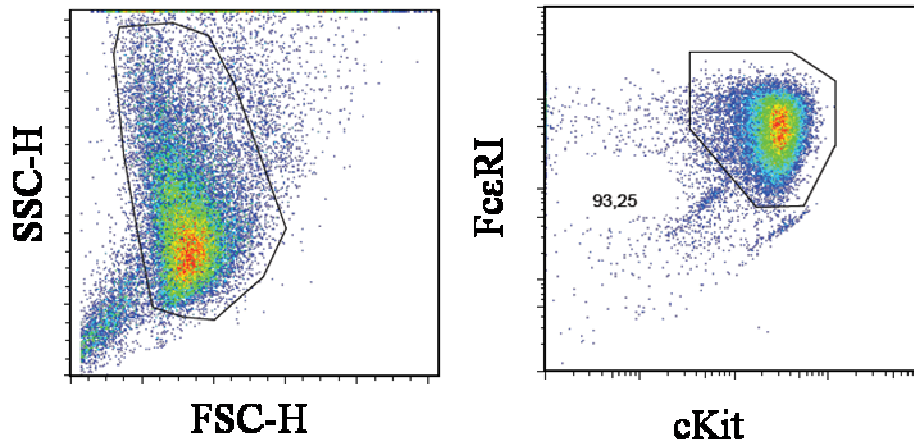
Female C57BL/6 (B6) mice (Harlan Laboratories) were used for all the experiments performed in this thesis. Femurs of BAFF-deficient (*baff*<sup>-/-</sup>) mice were kindly provided by Prof. P. Schneider from the Department of Biochemistry, University of Lausanne, Epalinges,

Switzerland. The MC/9 cell line is a cloned MC line derived from the fetal liver of a B6 X A/J F1 mouse. The human MC line HMC-1.2 was kindly provided by Prof. J. Rivera's laboratory. This cells are a factor-independent, fast growing, immature MC line derived from the peripheral blood of a patient suffering from MC leukemia. The human LAD2 MC line was kindly provided by A. Kirshenbaum (NIH, Bethesda, MD). This cell line was established from bone marrow aspirates of a patient with MC sarcoma leukemia and is closely related to human MCs. RAW 264.7 is a murine macrophage cell line. U937 cells are human monocytes derived from hystocytic lymphoma. HEK-293 are adherent embryonic kidney cells. RPMI 8226 cells are B lymphocytes derived from a myeloma, kindly provided by professor A. Vacca (Univerisity of Bari). C2C12 cells were a subclone (produced by H. Blau, et al) of the C2 mouse myoblast cell line established by D. Yaffe and O. Saxel. The A20 cell line is a BALB/c B cell lymphoma line derived from a reticulum cell sarcoma.

### **5.3. BMMCs differentiation and activation**

BMMCs were obtained by *in vitro* differentiation from *wt* and *baff*<sup>-/-</sup> mice. Murine MCs differentiated from bone marrow precursor cells are a useful tool to study the biological functions of these cells *ex vivo*. Bone marrow cells were isolated from the femurs of 5-6-week-old mice: the bones were dissected using scissors, cutting through the tibia below the knee joints, as well as through the pelvic bone close to the hip joint. The epiphysis was removed from femur and wash medium was injected in the cavity using a syringe (BD Plastipak) with a 30 gauge needle (Microlance). Cellular suspension was collected in a tube (Sarsted), centrifugated and resuspended in culture medium for BMMCs (see 5.1) which contains IL-3 and SCF that are specific factors for the differentiation of MCs. The maturation

of BMMCs was monitored assessing c-Kit and FcεRI expression by flow cytometry after 4-5 weeks. BMMCs were used when purity was more than 90-95%.



**Figure 5.1 . Purity of the bone marrow-derived MC population.** Representative example of FACS analysis to evaluate BMMC maturation. Mature BMMCs, gated on the basis of their size and granularity (FSC vs SSC plot, left side), are positively stained for both FcεRI and c-Kit (right panel).

For IgE-dependent stimulation, BMMCs were sensitized with 1 µg/ml of dinitrophenol (DNP)-specific IgE in medium without IL-3 for 3 h and then eventually treated with IgE specific Ag DNP (Sigma-Aldrich). Alternatively, MCs were activated in an IgE-independent manner, with IFN-γ (40 ng/ml) or LPS (1 µg/ml), which are other classical stimuli for MC-activation.

#### 5.4. Activation of the human MC lines HMC-1.2 and LAD2

Human cell lines were cultured in the appropriate media (as described in paragraph 5.1) and stimulated for 5 h. HMC-1.2 cells were stimulated with LPS (1 µg/ml) and with IFN-γ (8 ng/ml). LAD2 were stimulated with LPS (1 µg/ml) or overnight pre-sensitized with 1 µg/ml of human myeloma IgE and then stimulated with 15 µg/ml of anti-human IgE (Sigma-Aldrich).

### **5.5. $\beta$ -hexosaminidase release assay**

IgE-pre-sensitized BMMCs were challenged in Tyrode's buffer with DNP Ag (50 ng/ml) for 30 minutes. At the end of incubation, samples were placed on ice for 5 minutes and immediately centrifuged. The enzymatic activities of  $\beta$ -hexosaminidase in supernatants and in the cell pellets, after solubilization with 0.5% Triton X-100 in Tyrode's buffer, were measured with p-nitrophenyl N-acetyl-b-D-glucosaminide in 0.1 M sodium citrate (pH 4.5) for 60 minutes at 37°C. The release of the product 4-p-nitrophenol was detected by absorbance at 405 nm after addition of carbonate/bicarbonate tampon. The extent of degranulation was calculated as the percentage of 4-p-nitrophenol absorbance in the supernatants over the sum of absorbance and in cell pellets solubilized in detergent.

### **5.6. Total RNA isolation, RT-PCR and qPCR**

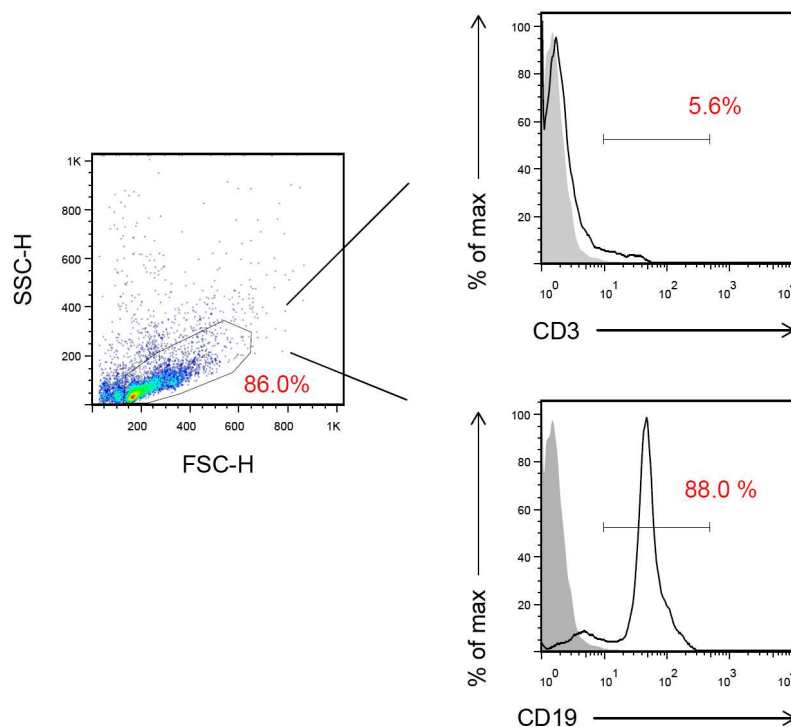
Total RNA was extracted from  $5 \times 10^6$  cells (either murine MCs, human MCs or B lymphocytes) using TRIzol (Invitrogen) or Riboex (GeneAll) reagent and according to the manufacturer's instructions. The extracted RNA was quantified using a spectrophotometer and by measuring the optical density at 260 nm. Its quality was checked by measuring the OD<sub>260</sub>/OD<sub>280</sub> ratio. RNA (1  $\mu$ g) was reverse transcribed to cDNA using the iScript cDNA Synthesis kit (Biorad) or the FirstStrand cDNA Synthesis Kit (Thermo Scientific), according to manufacturer's instructions. cDNA generated was amplified by reverse transcriptase polymerase chain reaction (RT-PCR) and/or by a quantitative real time PCR (qPCR), performed with a BioRad CFX device, using iQ<sup>TM</sup> SYBR Green Super Mix (Biorad). cDNA was amplified by PCR reaction with a mix contains (for samples): 2.5  $\mu$ l Buffer 10X RedTaq (Sigma), 0.5  $\mu$ l dNTPs mix (10mM), 0.9  $\mu$ l MgCl<sub>2</sub> 25mM, 0.25  $\mu$ l primer FOR (20 pmol/ $\mu$ l), 0.25  $\mu$ l primer REV (20 pmol/ $\mu$ l), 1  $\mu$ l Enzyme RedTaq (Sigma), 5  $\mu$ l cDNA. PCR was

performed with the following parameters: 94°C for 5 minutes, 40 cycles at (94°C for 45 sec; 59° C for 45 sec; 72°C for 60 sec) then 72 °C for 10 minutes. cDNA from each reaction was analyzed on a 2% agarose/EtBr gel, ran in 1X TAE buffer. Gel was analyzed with GelDoc (Biorad). Real Time PCR amplification were performed with the following parameters: 95°C for 3 minutes, followed by 39 cycles (95°C for 10 sec, temperature specific for each primer for 60 sec, for human and mouse BAFF, 30 sec for murine AID and APRIL). Specific temperatures were: mBAFF 64,5 °C, hBAFF 63,3 °C, mAID 58,9 °C. Specificity of the RT-PCR products was assessed by the generation of a melting curve. Data from the reaction, each performed in triplicate, were collected and analyzed by the complementary computer software. Results were expressed as fold induction compared to control condition. G3PDH (mouse) and GAPDH (human) transcripts levels were used as normalizer for samples. Length of segments are the following: mBAFF 169 bp, hBAFF 368 bp, mAID 106 bp, mG3PDH 115 bp, hGAPDH 452 bp. Primer used are the following: **murine BAFF** Forward: GACGCGCTTTCCAGGGACCAG Reverse: GTCGGCGTGTCGCTGTTCTGC **murine AID** Forward: AAGTCACGCTGGAGACCGAT Reverse: AGGTAGGTCTCATGCCGTCC **APRIL** Forward: ATGGGTCAGGTGGTGTCTCG Reverse: TCCCCTTGGTGTAATGGAAGA **murine G3PDH** Forward: TCAACAGCAACTCCCCTCTTCCA Reverse: ACCCTGTTGCTGTAGCCGTATTCA **human BAFF** Forward: CAGCTCCAGGAGAAGGCAACT Reverse: CAATGCCAGCTGAATAGCAGG **human GAPDH** Forward: ACCACAGTCCATGCCATC Reverse: TCCACCACCCTGTTGCTG .

### **5.7. Purification of mouse B cells**

Purified splenic B cells were obtained from 6-12-week-old mice by a negative depletion method that removes all undesired cells without manipulating the B cells themselves. Briefly,

spleens were removed and dissociated in PBS supplemented with 0.0192 M sodium citrate. Splenocyte cell suspension was depleted of red blood cells (RBCs) by hypotonic lysis with ACK lysing buffer (Sigma Aldrich) and of T cells by complement-mediated cytotoxic lysis using an anti-Thy 1.2 monoclonal Ab (a gift from K. Hathcock, Experimental Immunology Branch, NIC/NIH, Bethesda, MD USA) in conjunction with rabbit complement (Low-Tox M; Cedar Lane). The cell suspension was then cultured for at least one hour at 37°C and 5% CO<sub>2</sub> to allow the adhesion of mononuclear cells at the bottom of the flask. At the end of incubation, the cells in suspension were collected, washed and resuspended at a final concentration of 10<sup>6</sup> cell/ml in culture medium for B cells. To test the purity of the isolated B cells, a small aliquot of cells was checked by cytofluorimetric analysis for the expression of CD19; the percentage of CD19<sup>+</sup> cells varied between 85 and 95% (Fig. 5.2).



**Figure 5.2 . Purity of the B cell population isolated from mouse spleen.** In the scatter plot of forward scatter (FSC) vs side scatter (SSC) the cells are distributed based on their size and granularity. The lymphocytes (gated) form a tight population, clearly distinguishable from dead cells (on the left of the gated region) and from granulocytes (above the gated region). The histograms reported in the picture show how the majority of the isolated lymphocytes (87.9%) are B cells and that the contamination from T cells accounts for only the 5.6% of total cells.



### **5.8. Purification of human B cells**

For the purification of human B cells we followed the protocol of “*RosetteSep Human B cell enrichment cocktail*” kit (STEMCELL Technologies). This kit is designed to isolate B cells from whole blood by negative selection. The buffy coat of male healthy donors was provided by the “Azienda Ospedaliera Universitaria Santa Maria della Misericordia” of Udine. About 40 ml of buffy coat was incubated with *RosetteSep human B cell enrichment cocktail* (50 µl/ml). The *RosetteSep* Abs cocktail crosslinks unwanted cells in human whole blood to multiple RBCs, forming immunorosettes. This increases the density of the unwanted (rosetted) cells, such that they pellet along with the free RBCs when centrifuged over a buoyant density medium such as Ficoll-Paque PLUS. Desired cells are never labeled with Ab and are easily collected as a highly enriched population at the interface between the plasma and the buoyant density medium. After 20 minutes of incubation at room temperature, the sample was diluted with an equal volume of PBS plus 2% FBS and mixed gently. Then cells were further purified by separation in a Fycoll Paque Plus (GE Healthcare) density gradient and washed with PBS supplemented with 2% FBS. Human B cells were stained with human CD19 and then analyzed with FACS Calibur (Becton Dickinson) to ascertain the purity of the obtained cells. The cells were counted with Trypan Blue and resuspended in culture media RPMI (see 5.1) to be immediately used or frozen at -80 °C.

### **5.9. B/LAD2 co-culture and BrdU assay**

B and LAD cells were cultured in a 96-well plate (ratio 1:1) in 200 µl of StemPro (Gibco) medium (see 5.1). After 48 h of co-culture, 10 µM of Bromodeoxyuridine (BrdU, Sigma) were added in each well to proceed, 24h later, to BrdU assay detection. BrdU is a common reagent used for cell proliferation assays and for the detection of apoptotic cells. BrdU is a

uridine derivative and a structural analog of thymidine, and it can be incorporated into DNA during the synthesis-phase of the cell cycle as a substitute for thymidine, thereby serving as a marker for proliferation. Cells which have incorporated BrdU may be detected by multiple detection methods using fluorescently-labeled or enzyme-linked anti-BrdU Abs. Cells were collected and stained for CD19, to discriminate the B population. After staining, cells were washed with staining buffer, centrifuged and then resuspended in 200  $\mu$ l of Foxp3 Fixation/Permeabilization buffer (eBioscience) for 30 minutes at 4 °C. After washing, the cells were incubated with 100  $\mu$ l Dnase I (30 $\mu$ g/sample) to quantitatively expose BrdU-labeled epitopes in cell suspension. Cells were incubated for 1 h at 4 °C. Finally, cells were labeled with anti-BrdU FITC (eBioscience) (1:80) for about 40 minutes and analyzed with citofluorimeter (Becton Dickinson FACScan).

To evaluate the role of BAFF signaling pathway, the recombinant human TACI-Fc chimera (R&D) was added to the culture medium at the final concentration of 5  $\mu$ g/ml and maintained for all the 48 h of culture.

#### **5.10. CFSE staining of cell division**

In order to study lymphocyte proliferation, cells were stained with carboxyfluorescein diacetate succinimidyl ester (CFDA-SE) (Molecular Probes, Invitrogen). CFDA-SE diffuses into cells where the acetate groups on the molecule are cleaved to yield a highly fluorescent derivative (CFSE) that is retained in the cell and can be detected by flow cytometry. Cell division results in sequential halving of fluorescence and up to eight cell divisions can be monitored before the fluorescence is decreased to the background fluorescence of unstimulated cells (Parish et al., 2009).

Briefly,  $10^7$  B lymphocytes were washed and resuspended in 1 ml of complete culture medium for splenocytes. CFDA-SE was then added to a final concentration of 5  $\mu$ M and

incubated for 15 minutes at 37°C, in the dark. The reaction was blocked by adding 1 ml of cold FBS and cells were then centrifuged (300 g for 5 minutes) and washed two times with wash medium. Finally, B cells were resuspended at the final concentration of  $5 \times 10^5$  cell/ml in complete culture medium.

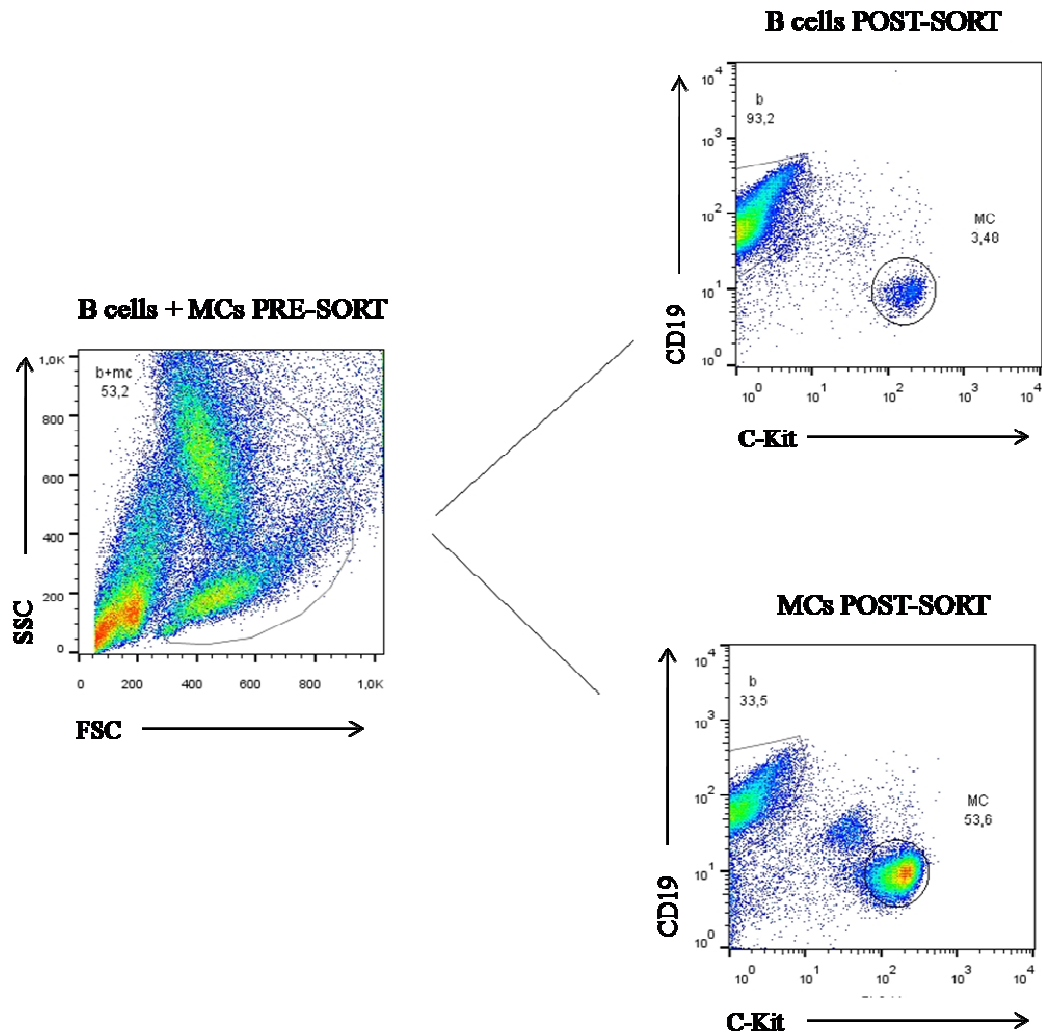
#### **5.11. Cytokine ELISA assay**

The test is a ‘sandwich ELISA’: the plate is coated with the capture Ab that recognizes the protein of interest (murine or human BAFF) in the samples. For the detection of the protein a second biotinylated Ab is used, that recognizes another epitope. Streptavidin-HRP and its substrate lead to a chromogenic reaction that allows the quantification of the protein present in the sample. Supernatants from different experimental settings were collected at the indicated times for quantification of murine (Boster Immunoleader) and human BAFF (R&D), through ELISA, according to manufacturer’s protocols.

#### **5.12. Co-culture of B lymphocyte with MCs**

For flow cytometry experiments, B cells were co-cultured with MCs.  $0.6 \times 10^6$  B cells were added to an equal number of IgE-sensitized or non-sensitized MCs, in the presence or absence of DNP, and cultured for 48 hours in a 24-well flat bottom plate (Corning Costar), in a final volume of 600  $\mu$ l. To evaluate the role of BAFF signaling pathway in the B lymphocyte-MC co-culture, the recombinant murine TACI-Fc chimera (R&D) was added to the culture medium at the final concentration of 1  $\mu$ g/ml and maintained for all the 48 h of culture. Otherwise B cells were cultured with MCs from *baff*<sup>-/-</sup> mice.

For RNA extraction, to measure AID gene expression in B cells,  $4 \times 10^6$  purified mouse B cells were cultured in flask of  $25 \text{ cm}^2$ , at the final concentration of  $1 \times 10^6$  cells/ml. B cells were cultured alone unstimulated, stimulated with anti-CD40 mAb ( $1 \text{ } \mu\text{g/ml}$ ) and anti-IgM mAb ( $0,5 \text{ } \mu\text{g/ml}$ ) or with anti-CD40 mAb ( $1 \text{ } \mu\text{g/ml}$ ) and IL-4 ( $50 \text{ ng/ml}$ ) or with MC (ratio 1:1) unstimulated or IgE/Ag-stimulated (see 5.3). Moreover to evaluate the role of BAFF signaling, the recombinant murine TACI-Fc chimera (R&D) was added to the culture medium at the final concentration of  $1 \text{ } \mu\text{g/ml}$ . AID expression was evaluated in RNA extracted from B cells (see 5.9) that were cultured for 96 h. AID transcripts were measured by qPCR in B cells cultured alone and in B cells which were separated from MCs through a immuno-affinity system, based on the use of magnetic beads conjugated to the anti-CD45R/B220 Ab (MACS Miltenyi Biotec). MS columns (MACS Miltenyi Biotec) were used according to protocol. To test the purity of the separated B cells, a small aliquot of cells was checked by cytofluorimetric analysis for the expression of CD19 (Fig. 5.3 ).

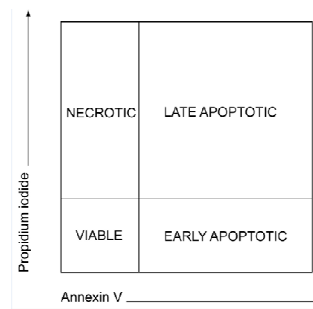


**Figure 5.3. Purity of post sorter B cells.** In the scatter plot of forward scatter (FSC) vs side scatter (SSC) the cells are distributed based on their size and granularity. The lymphocytes form a tight population, clearly distinguishable from dead cells (on the left of the gated region) and from MCs (above the gated region). The graphs on the right reported CD19/cKit stained cell. In the sample of cells post sorter, B cells represents 93.2 % of cells and MCs only the 3.48% (upper graph).

### 5.13. Murine B cell activation

Purified B cells were cultured in the presence or absence of substances known for their ability to induce B cell maturation and/or activation. In Annexin V/ Propidium iodide assay B cells were activated with recombinant human BAFF (Peprotech) (1  $\mu$ g/ml) and with LPS (Sigma Aldrich) (10  $\mu$ g/ml). In staining of BAFF-R and TACI and in experiments to evaluate AID expression B cells were activated with anti mouse CD40 mAb (1  $\mu$ g/ml) and anti IgM mAb (0,5  $\mu$ g/ml).

#### 5.14. Annexin V/ Propidium iodide assay



**Figure 5.4 Annexin V/Propidium Iodide assay.** Discrimination of viable, necrotic, late apoptotic and early apoptotic cells after staining with Annexin V (FITC) and Propidium Iodide (PI).

This viability test allows to discriminate necrotic, apoptotic and late apoptotic cells, as shown in Fig. 5.4. The assay was performed using the Annexin V-FITC kit (Bender MedSystem). Briefly, about 300.000 cells were stained with annexin (1:40) for 10 minutes in the dark at room temperature. After washing with PBS cells were stained with Propidium Iodide-PI (1:20) and then analyzed with the citofluorimeter. Before staining with Annexin V and Propidium Iodide, the cells were incubated with anti-mouse CD19 Pe-Cy5 or with anti-human CD19 Pe-Cy5 Abs.

#### 5.15. Staining for surface markers

To assess cell-surface expression of different co-stimulatory molecules and/or activation markers, about  $0.6 \times 10^6$  cells were collected into polystyrene tubes (Sarstedt), washed with PBS, resuspended and then incubated in the dark for 30 minutes at 4°C with a fluorescent mAb specific for a cell surface marker or with an Ig isotype-matched control. In the case of multicolor staining, other fluorescent Abs directed at various cell surface Ags were added at the same time. After the incubation, the cells were washed with Abs, resuspended in about 0.3 ml of PBS and kept at 4°C until flow cytometric analysis. The Abs used in the experiments performed for this thesis were conjugated either with fluorescein isothiocyanate (FITC),

phycoeritrin (PE), PE-Cy5 fluoro-chromes or allophycocyanin (APC). A complete list of the Abs used in this work is shown in the table here below:

**Table 5.1 – List of antibodies**

Specificity of Antibody	Reactivity	Isotype	Clone	Conjugated	Manufacturer	Work dilution
CD3	Mouse	Hamster IgG	145-2C11	FITC	ImmunoTools	1:100
CD19	Mouse	Rat IgG2a	1D3	FITC	eBioscience	1:100
CD19	Mouse	Rat IgG2a	6D5	PE-Cy5	BioLegend	1:125
BAFF	Mouse	IgM	Buffy-2	FITC	abCam	1:100
BAFF	Human	Mouse IgG1,k	T7-241	PE	Biolegend	1:20
BAFF	Human	Mouse IgG1,k	1D6	PE	eBioscience	1:33
BAFF-R	Mouse	Rat IgG1,k	eBio7H22-E16	APC	eBioscience	1:67
TACI	Mouse	Rat IgG2a,k	EBio8F10-3	APC	eBioscience	1:67
CD19	Human	Mouse IgG,k	HIB19	Pe-Cy5	Biolegend	1:20
CD154 (CD40L)	Mouse	Hamster IgG	MR1	PE	BioLegend	1:50
FcεR	Mouse	Hamster IgG	MAR-1	PE	BioLegend	1:100
CD117 (c-Kit)	Mouse	Rat IgG2b	2B8	PE-Cy5	eBioscience	1:100
IL-10	Mouse	Rat IgG2b,k	JES5-16E3	PE	Biolegend	1:50
CD138	Human	Mouse IgG1	MI15	FITC	BD	1:50
CD38	Human	Mouse IgG1	HB7	APC	BD	1:50
<b>Isotype controls</b>						
			<b>Clone</b>	<b>Conjugated</b>	<b>Manufacturer</b>	<b>Work dilution</b>
Rat IgG2a				FITC	BioLegend	1:100
Rat IgG2a				PE	BioLegend	1:100
Rat IgG2b				PE	eBioscience	1:100
Rat IgG2a				PE-Cy5	BioLegend	1:100
Mouse IgG1,k				PE	BD	1:20
Rat IgG1				APC	Biolegend	1:100

### 5.16. Preparation of protein extracts

For whole protein extracts,  $10 \times 10^6$  cells were collected, washed twice with ice-cold PBS and incubated for 30 minutes at 4°C, under gentle rotation, into 250  $\mu$ l of RIPA BUFFER: 50 mM TrisHCl (pH 8), 150mM NaCl, 1 % NP40 or Triton 100x, 0.1% SDS, 0.5% NaDOC, 20 nM NEM. Then extracts were centrifuged at 10000 g. for 30 minutes to remove all cell debris.. Whole cell extracts were quantified through Bradford assay and samples were used immediately for western blot or stored at -80°C for future use.

### 5.17. Western blot analysis

Whole extracts were obtained as described above. Extracts were electrophoresed on a 12% SDS-PAGE gel. The resolved proteins were transferred to a nitrocellulose membrane (Schleicher & Schuell, Keene, NH). The nonspecific binding sites on the membranes were blocked by incubation in 5% non-fat milk in PBS/0.1% Tween-20 and then incubated with the indicated primary Abs for 60 minutes at room temperature. After three washes with PBS/0.1% Tween-20, the membranes were incubated with the appropriate anti-Ig coupled to peroxidase. After 60 minutes of incubation at room temperature the membranes were washed several times with PBS/0.1% Tween-20. Proteins were detected by ECL chemiluminescence (Amersham Pharmacia Biotech) using Biomax-Light films (Kodak, Rochester, NY) and quantitated by Gel Doc 2000 (Bio-Rad Inc.).

**Table 5.2 – List of antibodies**

Specificity of Antibody	Reactivity	Isotype	Clone	Conjugated	Manufacturer	Work dilution
BAFF	Human		Polyclonal	-	abcam	1:250
BAFF	Mouse		Polyclonal	-	R&D	1:500



### **5.18. Intracellular staining for IL-10**

An intracellular staining protocol arranged by Tedder and Matsushita (Matsushita et al., 2010) was used to identify IL-10 producing B cells. Since the cytokine in basal conditions is not detectable, cells were treated with three different substances promoting its production. The stimulation lasted 5 h and were performed with a cocktail made by LPS (Sigma Aldrich) 10µg/ml, Phorbol 12-Myristate 13-Acetate (PMA, SIGMA-ALDRICH) 50 ng/ml and ionomycin (Sigma Aldrich) 500ng/ml. Finally 2 µM monensin (Sigma Aldrich) is added to block the exocytosis. After the stimulation,, staining protocol is performed. Every step is performed at 4°C with centrifugation at 300 g for 5 minutes. Cells were collected in tubes, centrifuged and washed with cold PBS. After that, to identify the live cells was used LIVE/DEAD Fixable Green Dead Cell Stain Probe (Invitrogen) that can bind cell membrane of live cells and can permeate in necrotic ones is used. Sequentially the Ab CD16/32 (Fc block) is added for 15 minutes to avoid aspecific binding derived from the interaction with Fc receptors. To identify B cells 50 µl of anti-CD19 Ab diluted in PBS were added and incubated for 30 minutes. Cells were washed and resuspended in 250 µL of Cytofix/Cytoperm (BD Biosciences), a solution containing formaldehyde to fix and permeabilize cells. After 20 minutes cells were washed twice with Perm/Wash Buffer. Then to detect the cytokine, an anti-IL-10 (Biolegend) Ab (or the isotype control) was added diluted in 50 µl Perm/Wash Buffer (BD Biosciences) and incubated for 30 minutes. Finally, the cells were washed with Perm/Wash Buffer and resuspended in 1.5% formaldehyde.

### **5.19. MTT assay**

The MTT assay is a colorimetric assay for assessing cell viability. Yellow MTT (3-(4,5-Dimethylthiazol-2-yl)-2,5- diphenyltetrazolium bromide, a tetrazole) is reduced to purple

formazan in the mitochondria of living cells. The absorbance of this colored solution can be quantified by measuring at a certain wavelength (usually between 500 and 600 nm) by a spectrophotometer. The absorption max is dependent on the solvent employed. This reduction takes place only when mitochondrial reductase enzymes are active and therefore conversion can be directly related to the number of viable (living) cells (Berridge et al., 2005).

It was added 100 µl of cells ( $0,75 \times 10^4$  cells) into each well of 96-well plate and incubate cells for 72 h. After that it was added 20 µl of 5mg/ml MTT to each well. Include one set of wells with MTT but no cells (control). Cells with MTT were incubated for 3,5 h at 37 °C in incubator. After that it was added 150 µl of DMSO, the place was cover with tinfoil and agitate cells on orbital shakes for 15 minutes. The adsorbance was read at 590 nm. Each condition was tested in duplicate.

## **5.20. Immunohistochemistry**

Four-µm thick paraffin sections were deparaffinised in HystoClear (AGTC Bioproducts, Hesse, UK) and rehydrated in graded alcohol series. Sections underwent microwave-oven heating in the Target Retrieval Solution pH 9 (Dako, Glostrup, Denmark) 1X for 15 minutes at 640W for Ag retrieval before endogenous peroxidase and alkaline phosphatase quenching. Double immunohistochemistry was performed using the EnVision G/2 Doublestain System, Rabbit/Mouse (DAB+/Permanent Red) kit (Dako) and the following primary Abs: monoclonal mouse anti-human MC tryptase (Dako), monoclonal rabbit anti-BAFF (Abcam). The counterstaining was performed by incubating sections with hematoxylin (Vector Laboratories, Burlingame, CA, USA) 1:1 in distilled water for 30 seconds. The slides were mounted with the Dako Glycergel™ Mounting Medium. Sections were examined by Zeiss

Axioplan 2 microscope (Carl Zeiss, Jena, Germany) and images acquired by Leica Application Suite V4.1 software (Leica Microsystems, Wetzlar, Germany).

### **5.21. Immunofluorescence**

Diagnostic Microscope Slides (10 Well 6 mm-Thermo Scientific) were coated with PolyLisine (1:10 H<sub>2</sub>O) at least 30 minutes. Cells (4x10<sup>4</sup> cells per well) were seeded into slides and fixed with 4% paraformaldehyde for 20 minutes at room temperature followed by permeabilization with 0.5% Triton X-100. Subsequently, reactive groups were blocked with FCS 10% in PBS for 30 minutes at room temperature. The cells were subjected to immunofluorescence staining with anti-BAFF Ab (1:50) (Buffy-2, Abcam) for 30 minutes at room temperature. After labelling, slides were washed and mounted with VECTASHIELD Mounting Medium with DAPI (Vector Laboratories). For acquisitions, slides were mounted on an inverted confocal microscope (Leica AF6000 LX), equipped with a 63 x 1.40 oil objective.

### **5.22. Data analysis**

Experimental data are represented as the mean  $\pm$  standard error of mean (SEM). Statistical significance of the data was calculated using the  $\tau$  student test. P values below 0.05 were considered as significant.

## 6. REFERENCES

- Abbas, A.K., Lichtman, A.H., and Pillai, S. (2012). Basic Immunology: Functions and Disorders of the Immune System. In *Basic Immunology: Functions and Disorders of the Immune System*, pp. 173–187.
- Abraham, S.N., and St John, A.L. (2010). Mast cell-orchestrated immunity to pathogens. *Nat. Rev. Immunol.* *10*, 440–452.
- Aggarwal, B.B., Gupta, S.C., and Kim, J.H. (2012). Historical perspectives on tumor necrosis factor and its superfamily: 25 years later, a golden journey. *Blood* *119*, 651–665.
- Akin, C., and Metcalfe, D.D. (2004). Systemic mastocytosis. *Annu. Rev. Med.* *55*, 419–432.
- Akin, C., Fumo, G., Yavuz, A.S., Lipsky, P.E., Neckers, L., and Metcalfe, D.D. (2004). A novel form of mastocytosis associated with a transmembrane c-kit mutation and response to imatinib. *Blood* *103*, 3222–3225.
- Alberts, B., Johnson, A., Lewis, J., Raff, M., Roberts, K., and And Walter, P. (2008). *Molecular Biology of the Cell*.
- Alt, F.W., Yancopoulos, G.D., Blackwell, T.K., Wood, C., Thomas, E., Boss, M., Coffman, R., Rosenberg, N., Tonegawa, S., and Baltimore, D. (1984). Ordered rearrangement of immunoglobulin heavy chain variable region segments. *EMBO J* *3*, 1209–1219.
- Amini, R.M., Aaltonen, K., Nevanlinna, H., Carvalho, R., Salonen, L., Heikkila, P., and Blomqvist, C. (2007). Mast cells and eosinophils in invasive breast carcinoma. *BMC Cancer* *7*, 165.
- Asseman, C., Mauze, S., Leach, M.W., Coffman, R.L., and Powrie, F. (1999). An essential role for interleukin 10 in the function of regulatory T cells that inhibit intestinal inflammation. *J. Exp. Med.* *190*, 995–1004.
- Bachelet, I., and Levi-Schaffer, F. (2007). Mast cells as effector cells: a co-stimulating question. *Trends Immunol.* *28*, 360–365.
- Bachmann, M.F., Hengartner, H., and Zinkernagel, R.M. (1995). T helper cell-independent neutralizing B cell response against vesicular stomatitis virus: Role of antigen patterns in B cell induction? *Eur. J. Immunol.* *25*, 3445–3451.
- Balkwill, F., Montfort, A., and Capasso, M. (2013). B regulatory cells in cancer. *Trends Immunol.* *34*, 169–173.
- Batten, M., Groom, J., Cachero, T.G., Qian, F., Schneider, P., Tschopp, J., Browning, J.L., and Mackay, F. (2000). BAFF mediates survival of peripheral immature B lymphocytes. *J. Exp. Med.* *192*, 1453–1466.
- Batten, M., Fletcher, C., Ng, L.G., Groom, J., Wheway, J., Laâbi, Y., Xin, X., Schneider, P., Tschopp, J., Mackay, C.R., et al. (2004). TNF deficiency fails to protect BAFF transgenic mice against autoimmunity and reveals a predisposition to B cell lymphoma. *J. Immunol.* *172*, 812–822.
- Baud, V., and Karin, M. (2001). Signal transduction by tumor necrosis factor and its relatives. *Trends Cell Biol.* *11*, 372–377.

- Bergsagel, P.L., Kuehl, W.M., Zhan, F., Sawyer, J., Barlogie, B., and Shaughnessy, J. (2005). Cyclin D dysregulation: An early and unifying pathogenic event in multiple myeloma. *Blood* *106*, 296–303.
- Berridge, M. V., Herst, P.M., and Tan, A.S. (2005). Tetrazolium dyes as tools in cell biology: New insights into their cellular reduction. *Biotechnol. Annu. Rev.* *11*, 127–152.
- Bischoff, S.C. (2007). Role of mast cells in allergic and non-allergic immune responses: comparison of human and murine data. *Nat. Rev. Immunol.* *7*, 93–104.
- Bodmer, J.-L., Schneider, P., and Tschopp, J. (2002). The molecular architecture of the TNF superfamily. *Trends Biochem. Sci.* *27*, 19–26.
- Bosello, S., Youinou, P., Daridon, C., Tolusso, B., Bendaoud, B., Pietrapertosa, D., Morelli, A., and Ferraccioli, G. (2008). Concentrations of BAFF correlate with autoantibody levels, clinical disease activity, and response to treatment in early rheumatoid arthritis. *J. Rheumatol.* *35*, 1256–1264.
- Bossen, C., Cachero, T.G., Tardivel, A., Ingold, K., Willen, L., Dobles, M., Scott, M.L., Maquelin, A., Belnoue, E., Siegrist, C.-A., et al. (2008). TACI, unlike BAFF-R, is solely activated by oligomeric BAFF and APRIL to support survival of activated B cells and plasmablasts. *Blood* *111*, 1004–1012.
- Bülow, G.U., and Bram, R.J. (1997). NF-AT activation induced by a CAML-interacting member of the tumor necrosis factor receptor superfamily. *Science* *278*, 138–141.
- Busslinger, M. (2004). Transcriptional control of early B cell development. *Annu. Rev. Immunol.* *22*, 55–79.
- Cachero, T.G., Schwartz, I.M., Qian, F., Day, E.S., Bossen, C., Ingold, K., Tardivel, A., Krushinskie, D., Eldredge, J., Silvian, L., et al. (2006). Formation of virus-like clusters is an intrinsic property of the tumor necrosis factor family member BAFF (B cell activating factor). *Biochemistry* *45*, 2006–2013.
- Cancro, M.P. (2006). The BLyS/BAFF family of ligands and receptors: key targets in the therapy and understanding of autoimmunity. *Ann. Rheum. Dis.* *65 Suppl 3*, iii34–i36.
- Candando, K.M., Lykken, J.M., and Tedder, T.F. (2014). B10 cell regulation of health and disease. *Immunol. Rev.* *259*, 259–272.
- Caron, G., Delneste, Y., Roelandts, E., Duez, C., Bonnefoy, J.Y., Pestel, J., and Jeannin, P. (2001). Histamine polarizes human dendritic cells into Th2 cell-promoting effector dendritic cells. *J. Immunol.* *167*, 3682–3686.
- Castigli, E., Wilson, S.A., Scott, S., Dedeoglu, F., Xu, S., Lam, K.-P., Bram, R.J., Jabara, H., and Geha, R.S. (2005). TACI and BAFF-R mediate isotype switching in B cells. *J. Exp. Med.* *201*, 35–39.
- Cerutti, A., Cols, M., and Puga, I. (2013). Marginal zone B cells: virtues of innate-like antibody-producing lymphocytes. *Nat. Rev. Immunol.* *13*, 118–132.
- Chaudhuri, J., and Alt, F.W. (2004). Class-switch recombination: interplay of transcription, DNA deamination and DNA repair. *Nat. Rev. Immunol.* *4*, 541–552.
- Cheema, G.S., Roschke, V., Hilbert, D.M., and Stohl, W. (2001). Elevated serum B lymphocyte stimulator levels in patients with systemic immune-based rheumatic diseases. *Arthritis Rheum.* *44*, 1313–1319.

- Chen, C.-C., Grimbaldston, M.A., Tsai, M., Weissman, I.L., and Galli, S.J. (2005). Identification of mast cell progenitors in adult mice. *Proc. Natl. Acad. Sci. U. S. A.* *102*, 11408–11413.
- Chesi, M., Robbiani, D.F., Sebag, M., Chng, W.J., Affer, M., Tiedemann, R., Valdez, R., Palmer, S.E., Haas, S.S., Stewart, A.K., et al. (2008). AID-Dependent Activation of a MYC Transgene Induces Multiple Myeloma in a Conditional Mouse Model of Post-Germinal Center Malignancies. *Cancer Cell* *13*, 167–180.
- Chicheportiche, Y., Bourdon, P.R., Xu, H., Hsu, Y.M., Scott, H., Hession, C., Garcia, I., and Browning, J.L. (1997). TWEAK, a new secreted ligand in the tumor necrosis factor family that weakly induces apoptosis. *J. Biol. Chem.* *272*, 32401–32410.
- Chiu, A., Xu, W., He, B., Dillon, S.R., Gross, J.A., Sievers, E., Qiao, X., Santini, P., Hyjek, E., Lee, J.W., et al. (2007). Hodgkin lymphoma cells express TACI and BCMA receptors and generate survival and proliferation signals in response to BAFF and APRIL. *Blood* *109*, 729–739.
- Chu, V.T., Enghard, P., Schürer, S., Steinhäuser, G., Rudolph, B., Riemekasten, G., and Berek, C. (2009). Systemic activation of the immune system induces aberrant BAFF and APRIL expression in B cells in patients with systemic lupus erythematosus. *Arthritis Rheum.* *60*, 2083–2093.
- Coquery, C.M., and Erickson, L.D. (2012). Regulatory roles of the tumor necrosis factor receptor BCMA. *Crit. Rev. Immunol.* *32*, 287–305.
- Craxton, A., Magaletti, D., Ryan, E.J., and Clark, E.A. (2003). Macrophage- and dendritic cell-dependent regulation of human B-cell proliferation requires the TNF family ligand BAFF. *Blood* *101*, 4464–4471.
- Dabiri, S., Huntsman, D., Makretsov, N., Cheang, M., Gilks, B., Bajdik, C., Gelmon, K., Chia, S., and Hayes, M. (2004). The presence of stromal mast cells identifies a subset of invasive breast cancers with a favorable prognosis. *Mod. Pathol.* *17*, 690–695.
- Daridon, C., Devauchelle, V., Hutin, P., Le Berre, R., Martins-Carvalho, C., Bendaoud, B., Dueymes, M., Saraux, A., Youinou, P., and Pers, J.O. (2007). Aberrant expression of BAFF by B lymphocytes infiltrating the salivary glands of patients with primary Sjögren's syndrome. *Arthritis Rheum.* *56*, 1134–1144.
- Daridon, C., Youinou, P., and Pers, J.-O. (2008). BAFF, APRIL, TWE-PRIL: who's who? *Autoimmun. Rev.* *7*, 267–271.
- DiLillo, D.J., Matsushita, T., and Tedder, T.F. (2010). B10 cells and regulatory B cells balance immune responses during inflammation, autoimmunity, and cancer. *Ann. N. Y. Acad. Sci.* *1183*, 38–57.
- Ding, H.J., and Gordon, C. (2013). New biologic therapy for systemic lupus erythematosus. *Curr. Opin. Pharmacol.* *13*, 405–412.
- Doria, A., and Iaccarino, L. (2013). L'impiego di belimumab nel Lupus eritematoso sistemico: risultati di una valutazione di HTA. *2*.
- Durandy, A., Cantaert, T., Kracker, S., and Meffre, E. (2013). Potential roles of activation-induced cytidine deaminase in promotion or prevention of autoimmunity in humans. *Autoimmunity* *46*, 148–156.

- Ehrlich P (1878). Beiträge zur Kenntnis der Anilinfärbungen und ihrer Verwendung in der mikroskopischen Technik.
- Elpek, G., Gelen, T., Aksoy, N., Erdogan, A., Dertsiz, L., Demircan, A., and Keles, N. (2001). The prognostic relevance of angiogenesis and mast cells in squamous cell carcinoma of the oesophagus. *J Clin Pathol* 54, 940–944.
- Elsawa, S.F., Novak, A.J., Grote, D.M., Ziesmer, S.C., Witzig, T.E., Kyle, R.A., Dillon, S.R., Harder, B., Gross, J.A., and Ansell, S.M. (2006). B-lymphocyte stimulator (BLyS) stimulates immunoglobulin production and malignant B-cell growth in Waldenström macroglobulinemia. *Blood* 107, 2882–2888.
- Fehr, T., Bachmann, M.F., Bluethmann, H., Kikutani, H., Hengartner, H., and Zinkernagel, R.M. (1996). T-independent activation of B cells by vesicular stomatitis virus: no evidence for the need of a second signal. *Cell. Immunol.* 168, 184–192.
- Fragioudaki, M., Boula, A., Tsirakis, G., Psarakis, F., Spanoudakis, M., Papadakis, I.S., Pappa, C.A., and Alexandrakis, M.G. (2012). B cell-activating factor: Its clinical significance in multiple myeloma patients. *Ann. Hematol.* 91, 1413–1418.
- Frossi, B., De Carli, M., and Pucillo, C. (2004). The mast cell: an antenna of the microenvironment that directs the immune response. *J. Leukoc. Biol.* 75, 579–585.
- Fu, L., Lin-Lee, Y.-C., Pham, L. V, Tamayo, A.T., Yoshimura, L.C., and Ford, R.J. (2009). BAFF-R promotes cell proliferation and survival through interaction with IKKbeta and NF-kappaB/c-Rel in the nucleus of normal and neoplastic B-lymphoid cells. *Blood* 113, 4627–4636.
- Galli, S.J., and Tsai, M. (2008). Mast cells: Versatile regulators of inflammation, tissue remodeling, host defense and homeostasis. *J. Dermatol. Sci.* 49, 7–19.
- Galli, S.J., Maurer, M., and Lantz, C.S. (1999). Mast cells as sentinels of innate immunity. *Curr. Opin. Immunol.* 11, 53–59.
- Galli, S.J., Nakae, S., and Tsai, M. (2005a). Mast cells in the development of adaptive immune responses. *Nat. Immunol.* 6, 135–142.
- Galli, S.J., Kalesnikoff, J., Grimbaldston, M. a, Piliponsky, A.M., Williams, C.M.M., and Tsai, M. (2005b). Mast cells as “tunable” effector and immunoregulatory cells: recent advances. *Annu. Rev. Immunol.* 23, 749–786.
- Galli, S.J., Borregaard, N., and Wynn, T.A. (2011). Phenotypic and functional plasticity of cells of innate immunity: macrophages, mast cells and neutrophils. *Nat. Immunol.* 12, 1035–1044.
- Garfield, R.E., Irani, A.M., Schwartz, L.B., Bytautiene, E., and Romero, R. (2006). Structural and functional comparison of mast cells in the pregnant versus nonpregnant human uterus. *Am. J. Obstet. Gynecol.* 194, 261–267.
- Gauchat, J.F., Henchoz, S., Mazzei, G., Aubry, J.P., Brunner, T., Blasey, H., Life, P., Talabot, D., Flores-Romo, L., and Thompson, J. (1993). Induction of human IgE synthesis in B cells by mast cells and basophils. *Nature* 365, 340–343.
- Gavin, A.L., Ait-Azzouzene, D., Ware, C.F., and Nemazee, D. (2003). DeltaBAFF, an alternate splice isoform that regulates receptor binding and biopresentation of the B cell survival cytokine, BAFF. *J. Biol. Chem.* 278, 38220–38228.

- Gavin, A.L., Duong, B., Skog, P., Ait-Azzouzene, D., Greaves, D.R., Scott, M.L., and Nemazee, D. (2005). deltaBAFF, a splice isoform of BAFF, opposes full-length BAFF activity in vivo in transgenic mouse models. *J. Immunol.* *175*, 319–328.
- Genovese, M.C., Fleischmann, R.M., Greenwald, M., Satterwhite, J., Veenhuizen, M., Xie, L., Berclaz, P.-Y., Myers, S., and Benichou, O. (2013). Tabalumab, an anti-BAFF monoclonal antibody, in patients with active rheumatoid arthritis with an inadequate response to TNF inhibitors. *Ann. Rheum. Dis.* *72*, 1461–1468.
- George-Chandy, A., Trysberg, E., and Eriksson, K. (2008). Raised intrathecal levels of APRIL and BAFF in patients with systemic lupus erythematosus: relationship to neuropsychiatric symptoms. *Arthritis Res. Ther.* *10*, R97.
- Ghobrial, I.M. (2012). Myeloma as a model for the process of metastasis: Implications for therapy. *Blood* *120*, 20–30.
- Gilfillan, A.M., and Beaven, M.A. (2011). Regulation of Mast Cell Responses in Health and Disease. *Crit. Rev. Immunol.* *31*, 475–530.
- Gong, S., and Nussenzweig, M.C. (1996). Regulation of an early developmental checkpoint in the B cell pathway by Ig beta. *Science* *272*, 411–414.
- Gordon, J.R., and Galli, S.J. (1990). Mast cells as a source of both preformed and immunologically inducible TNF-alpha/cachectin. *Nature* *346*, 274–276.
- Gordon, N.C., Pan, B., Hymowitz, S.G., Yin, J., Kelley, R.F., Cochran, A.G., Yan, M., Dixit, V.M., Fairbrother, W.J., and Starovasnik, M.A. (2003). BAFF/BLyS receptor 3 comprises a minimal TNF receptor-like module that encodes a highly focused ligand-binding site. *Biochemistry* *42*, 5977–5983.
- Gri, G., Piconese, S., Frossi, B., Manfredi, V., Merluzzi, S., Tripodo, C., Viola, A., Odom, S., Rivera, J., Colombo, M.P., et al. (2008). CD4+CD25+ Regulatory T Cells Suppress Mast Cell Degranulation and Allergic Responses through OX40-OX40L Interaction. *Immunity* *29*, 771–781.
- Gri, G., Frossi, B., D’Inca, F., Danelli, L., Betto, E., Mion, F., Sibilano, R., and Pucillo, C. (2012). Mast cell: an emerging partner in immune interaction. *Front. Immunol.* *3*, 120.
- Grivennikov, S.I., Greten, F.R., and Karin, M. (2010). Immunity, Inflammation, and Cancer. *Cell* *140*, 883–899.
- Groom, J., Kalled, S.L., Cutler, A.H., Olson, C., Woodcock, S.A., Schneider, P., Tschopp, J., Cachero, T.G., Batten, M., Wheway, J., et al. (2002). Association of BAFF/BLyS overexpression and altered B cell differentiation with Sjögren’s syndrome. *J. Clin. Invest.* *109*, 59–68.
- Gross, J.A., Johnston, J., Mudri, S., Enselman, R., Dillon, S.R., Madden, K., Xu, W., Parrish-Novak, J., Foster, D., Lofton-Day, C., et al. (2000). TACI and BCMA are receptors for a TNF homologue implicated in B-cell autoimmune disease. *Nature* *404*, 995–999.
- Gruss, H.J., and Dower, S.K. (1995). Tumor necrosis factor ligand superfamily: involvement in the pathology of malignant lymphomas. *Blood* *85*, 3378–3404.
- Guhl, S., Babina, M., Neou, A., Zuberbier, T., and Artuc, M. (2010). Mast cell lines HMC-1 and LAD2 in comparison with mature human skin mast cells--drastically reduced levels of tryptase and chymase in mast cell lines. *Exp. Dermatol.* *19*, 845–847.



- Haiat, S., Billard, C., Quiney, C., Ajchenbaum-Cymbalista, F., and Kolb, J.P. (2006). Role of BAFF and APRIL in human B-cell chronic lymphocytic leukaemia. *Immunology* *118*, 281–292.
- Hallgren, J., and Gurish, M.F. (2011). Mast cell progenitor trafficking and maturation. *Adv. Exp. Med. Biol.* *716*, 14–28.
- Hanahan, D., and Weinberg, R.A. (2011). Hallmarks of cancer: The next generation. *Cell* *144*, 646–674.
- Hardy, R.R., and Hayakawa, K. (2001). B cell development pathways. *Annu. Rev. Immunol.* *19*, 595–621.
- Hardy, R.R., Carmack, C.E., Shinton, S.A., Kemp, J.D., and Hayakawa, K. (1991). Resolution and characterization of pro-B and pre-pro-B cell stages in normal mouse bone marrow. *J. Exp. Med.* *173*, 1213–1225.
- Hauser, J., Sveshnikova, N., Wallenius, A., Baradaran, S., Saarikettu, J., and Grundström, T. (2008). B-cell receptor activation inhibits AID expression through calmodulin inhibition of E-proteins. *Proc. Natl. Acad. Sci. U. S. A.* *105*, 1267–1272.
- He, B., Chadburn, A., Jou, E., Schattner, E.J., Knowles, D.M., and Cerutti, A. (2004). Lymphoma B cells evade apoptosis through the TNF family members BAFF/BLyS and APRIL. *J. Immunol.* *172*, 3268–3279.
- He, B., Santamaria, R., Xu, W., Cols, M., Chen, K., Puga, I., Shan, M., Xiong, H., Bussel, J.B., Chiu, A., et al. (2010). The transmembrane activator TACI triggers immunoglobulin class switching by activating B cells through the adaptor MyD88. *Nat. Immunol.* *11*, 836–845.
- Henderson, A., and Calame, K. (1998). Transcriptional regulation during B cell development. *Annu Rev Immunol* *16*, 163–200.
- Henz, B.M., Maurer, M., Lippert, U., Worm, M., and Babina, M. (2001). Mast cells as initiators of immunity and host defense. *Exp. Dermatol.* *10*, 1–10.
- Ho, A.W., Hatjiharissi, E., Ciccarelli, B.T., Branagan, A.R., Hunter, Z.R., Leleu, X., Tournilhac, O., Xu, L., O'Connor, K., Manning, R.J., et al. (2008). CD27-CD70 interactions in the pathogenesis of Waldenström macroglobulinemia. *Blood* *112*, 4683–4689.
- Hofmann, A.M., and Abraham, S.N. (2009). New roles for mast cells in modulating allergic reactions and immunity against pathogens. *Curr. Opin. Immunol.* *21*, 679–686.
- Honjo, T., Kinoshita, K., and Muramatsu, M. (2002). Molecular mechanism of class switch recombination: linkage with somatic hypermutation. *Annu. Rev. Immunol.* *20*, 165–196.
- Hsu, B.L., Harless, S.M., Lindsley, R.C., Hilbert, D.M., and Cancro, M.P. (2002). Cutting edge: BLyS enables survival of transitional and mature B cells through distinct mediators. *J. Immunol.* *168*, 5993–5996.
- Huard, B., Arlettaz, L., Ambrose, C., Kindler, V., Mauri, D., Roosnek, E., Tschopp, J., Schneider, P., and French, L.E. (2004). BAFF production by antigen-presenting cells provides T cell co-stimulation. *Int. Immunol.* *16*, 467–475.
- Huntington, N.D., Tomioka, R., Clavarino, C., Chow, A.M., Liñares, D., Maña, P., Rossjohn, J., Cachero, T.G., Qian, F., Kalled, S.L., et al. (2006). A BAFF antagonist suppresses experimental

- autoimmune encephalomyelitis by targeting cell-mediated and humoral immune responses. *Int. Immunol.* *18*, 1473–1485.
- Irani, A.M., and Schwartz, L.B. (1994). Human mast cell heterogeneity. *Allergy Proc. Off. J. Reg. State Allergy Soc.* *15*, 303–308.
- Irani, A.A., Schechter, N.M., Craig, S.S., DeBlois, G., and Schwartz, L.B. (1986). Two types of human mast cells that have distinct neutral protease compositions. *Proc Natl Acad Sci U S A* *83*, 4464–4468.
- Jacobi, A.M., and Diamond, B. (2005). Balancing diversity and tolerance: lessons from patients with systemic lupus erythematosus. *J. Exp. Med.* *202*, 341–344.
- Jarboe, D.L., and Huff, T.F. (1989). The mast cell-committed progenitor. II. W/W<sup>v</sup> mice do not make mast cell-committed progenitors and S1/S1d fibroblasts do not support development of normal mast cell-committed progenitors. *J. Immunol.* *142*, 2418–2423.
- Jiang, C., Foley, J., Clayton, N., Kissling, G., Jokinen, M., Herbert, R., and Diaz, M. (2007). Abrogation of lupus nephritis in activation-induced deaminase-deficient MRL/lpr mice. *J. Immunol.* *178*, 7422–7431.
- Jun-ichi Kashiwakura, Hidenori Yokoi, H.S. and Y.O. (2004). T cell proliferation by direct cross-talk between OX40 ligand on human mast cells and OX40 on human T cells: comparison of gene expression profiles between human tonsillar and lung-cultured mast cells.
- Kalled, S.L. (2006). Impact of the BAFF/BR3 axis on B cell survival, germinal center maintenance and antibody production. *Semin. Immunol.* *18*, 290–296.
- Kambayashi, T., Allenspach, E.J., Chang, J.T., Zou, T., Shoag, J.E., Reiner, S.L., Caton, A.J., and Koretzky, G.A. (2009). Inducible MHC class II expression by mast cells supports effector and regulatory T cell activation. *J. Immunol.* *182*, 4686–4695.
- Kanakaraj, P., Migone, T.S., Nardelli, B., Ullrich, S., Li, Y., Olsen, H.S., Salcedo, T.W., Kaufman, T., Cochrane, E., Gan, Y., et al. (2001). BLyS binds to B cells with high affinity and induces activation of the transcription factors NF-kappaB and ELF-1. *Cytokine* *13*, 25–31.
- Karasuyama, H., Kudo, A., and Melchers, F. (1990). The proteins encoded by the VpreB and lambda 5 pre-B cell-specific genes can associate with each other and with mu heavy chain. *J. Exp. Med.* *172*, 969–972.
- Karpusas, M., Cachero, T.G., Qian, F., Boriack-Sjodin, A., Mullen, C., Strauch, K., Hsu, Y.-M., and Kalled, S.L. (2002). Crystal structure of extracellular human BAFF, a TNF family member that stimulates B lymphocytes. *J. Mol. Biol.* *315*, 1145–1154.
- Kawabe, T., Naka, T., Yoshida, K., Tanaka, T., Fujiwara, H., Suematsu, S., Yoshida, N., Kishimoto, T., and Kikutani, H. (1994). The immune responses in CD40-deficient mice: impaired immunoglobulin class switching and germinal center formation. *Immunity* *1*, 167–178.
- Kawasaki, A., Tsuchiya, N., Fukazawa, T., Hashimoto, H., and Tokunaga, K. (2002). Analysis on the association of human BLyS (BAFF, TNFSF13B) polymorphisms with systemic lupus erythematosus and rheumatoid arthritis. *Genes Immun.* *3*, 424–429.

- Kern, C., Cornuel, J.F., Billard, C., Tang, R., Rouillard, D., Stenou, V., Defrance, T., Ajchenbaum-Cymbalista, F., Simonin, P.Y., Feldblum, S., et al. (2004). Involvement of BAFF and APRIL in the resistance to apoptosis of B-CLL through an autocrine pathway. *Blood* 103, 679–688.
- Kim, H.-A., Jeon, S.-H., Seo, G.-Y., Park, J.-B., and Kim, P.-H. (2008). TGF-beta1 and IFN-gamma stimulate mouse macrophages to express BAFF via different signaling pathways. *J. Leukoc. Biol.* 83, 1431–1439.
- Kim, H.-A., Seo, G.-Y., and Kim, P.-H. (2011). Macrophage-derived BAFF induces AID expression through the p38MAPK/CREB and JNK/AP-1 pathways. *J. Leukoc. Biol.* 89, 393–398.
- Kim, R.J., Kim, H.A., Park, J.B., Park, S.R., Jeon, S.H., Seo, G.Y., Seo, D.W., Seo, S.R., Chun, G.T., Kim, N.S., et al. (2007). IL-4-induced AID expression and its relevance to IgA class switch recombination. *Biochem. Biophys. Res. Commun.* 361, 398–403.
- Kinet, J.P. (1999). The high-affinity IgE receptor (Fc epsilon RI): from physiology to pathology. *Annu. Rev. Immunol.* 17, 931–972.
- Kitamura, Y., Go, S., and Hatanaka, K. (1978). Decrease of mast cells in W/W<sup>v</sup> mice and their increase by bone marrow transplantation. *Blood* 52, 447–452.
- Kitamura, Y., Matsuda, H., and Hatanaka, K. (1979a). Clonal nature of mast-cell clusters formed in W/W<sup>v</sup> mice after bone marrow transplantation. *Nature* 281, 154–155.
- Kitamura, Y., Hatanaka, K., Murakami, M., and Shibata, H. (1979b). Presence of mast cell precursors in peripheral blood of mice demonstrated by parabiosis. *Blood* 53, 1085–1088.
- Kitamura, Y., Kasugai, T., Arizono, N., and Matsuda, H. (1993). Development of mast cells and basophils: processes and regulation mechanisms. *Am. J. Med. Sci.* 306, 185–191.
- Kitamura, Y., Oboki, K., and Ito, A. (2007). Development of mast cells. *Proc. Japan Acad. Ser. B* 83, 164–174.
- Kooten, C. Van, and Banchereau, J. (1997). Functions of CD40 on B cells, dendritic cells and other cells. *Curr. Opin. Immunol.* 9, 330–337.
- Kuehl, W.M., and Bergsagel, P.L. (2002). Multiple myeloma: evolving genetic events and host interactions. *Nat. Rev. Cancer* 2, 175–187.
- Kulka, M., and Metcalfe, D.D. (2005). High-resolution tracking of cell division demonstrates differential effects of TH1 and TH2 cytokines on SCF-dependent human mast cell production in vitro: Correlation with apoptosis and Kit expression. *Blood* 105, 592–599.
- Laabi, Y., Gras, M.P., Brouet, J.C., Berger, R., Larsen, C.J., and Tsapis, A. (1994). The BCMA gene, preferentially expressed during B lymphoid maturation, is bidirectionally transcribed. *Nucleic Acids Res.* 22, 1147–1154.
- Lahiri, A., Pochard, P., Le Pottier, L., Tobón, G.J., Bendaoud, B., Youinou, P., and Pers, J.O. (2012). The complexity of the BAFF TNF-family members: Implications for autoimmunity. *J. Autoimmun.* 39, 189–198.
- Landgren, O., Kyle, R.A., Pfeiffer, R.M., Katzmann, J.A., Caporaso, N.E., Hayes, R.B., Dispenzieri, A., Kumar, S., Clark, R.J., Baris, D., et al. (2009). Monoclonal gammopathy of undetermined

- significance (MGUS) consistently precedes multiple myeloma: A prospective study. *Blood* *113*, 5412–5417.
- LeBien, T.W. (2000). Fates of human B-cell precursors. *Blood* *96*, 9–23.
- Lebien, T.W., and Tedder, T.F. (2008a). ASH 50th anniversary review B lymphocytes : how they develop and function. *112*, 1570–1580.
- Lebien, T.W., and Tedder, T.F. (2008b). B lymphocytes: How they develop and function. *Blood* *112*, 1570–1580.
- Lesley, R., Xu, Y., Kalled, S.L., Hess, D.M., Schwab, S.R., Shu, H.-B., and Cyster, J.G. (2004). Reduced competitiveness of autoantigen-engaged B cells due to increased dependence on BAFF. *Immunity* *20*, 441–453.
- Li, Y.S., Hayakawa, K., and Hardy, R.R. (1993). The regulated expression of B lineage associated genes during B cell differentiation in bone marrow and fetal liver. *J. Exp. Med.* *178*, 951–960.
- Liang, D., Zeng, Q., Xu, Z., Zhang, H., Gui, L., Xu, C., Chen, S., Zhang, S., Huang, S., and Chen, L. (2014). BAFF activates Erk1/2 promoting cell proliferation and survival by Ca<sup>2+</sup>-CaMKII-dependent inhibition of PP2A in normal and neoplastic B-lymphoid cells. *Biochem. Pharmacol.* *87*, 332–343.
- Litinskiy, M.B., Nardelli, B., Hilbert, D.M., He, B., Schaffer, A., Casali, P., and Cerutti, A. (2002). DCs induce CD40-independent immunoglobulin class switching through BLyS and APRIL. *Nat. Immunol.* *3*, 822–829.
- Litman, G.W., Cannon, J.P., and Dishaw, L.J. (2005). Reconstructing immune phylogeny: new perspectives. *Nat. Rev. Immunol.* *5*, 866–879.
- Liu, Y., Xu, L., Opalka, N., Kappler, J., Shu, H.B., and Zhang, G. (2002). Crystal structure of sTALL-1 reveals a virus-like assembly of TNF family ligands. *Cell* *108*, 383–394.
- Loder, F., Mutschler, B., Ray, R.J., Paige, C.J., Sideras, P., Torres, R., Lamers, M.C., and Carsetti, R. (1999). B cell development in the spleen takes place in discrete steps and is determined by the quality of B cell receptor-derived signals. *J. Exp. Med.* *190*, 75–89.
- Longerich, S., Basu, U., Alt, F., and Storb, U. (2006). AID in somatic hypermutation and class switch recombination. *Curr. Opin. Immunol.* *18*, 164–174.
- Lund, F.E., Garvy, B.A., Randall, T.D., and Harris, D.P. (2005). Regulatory roles for cytokine-producing B cells in infection and autoimmune disease. *Curr. Dir. Autoimmun.* *8*, 25–54.
- Mackay, F., and Browning, J.L. (2002). BAFF: a fundamental survival factor for B cells. *Nat. Rev. Immunol.* *2*, 465–475.
- Mackay, F., and Schneider, P. (2009). Cracking the BAFF code. *Nat. Rev. Immunol.* *9*, 491–502.
- Mackay, F., and Schneider, P. (2010). TACI, an enigmatic BAFF/APRIL receptor, with new unappreciated biochemical and biological properties. *Cytokine Growth Factor Rev.* *19*, 263–276.
- Mackay, F., and Tangye, S.G. (2004). The role of the BAFF/APRIL system in B cell homeostasis and lymphoid cancers. *Curr. Opin. Pharmacol.* *4*, 347–354.

- Mackay, F., Woodcock, S. a, Lawton, P., Ambrose, C., Baetscher, M., Schneider, P., Tschopp, J., and Browning, J.L. (1999). Mice transgenic for BAFF develop lymphocytic disorders along with autoimmune manifestations. *J. Exp. Med.* *190*, 1697–1710.
- Mackay, F., Schneider, P., Rennert, P., and Browning, J. (2003). BAFF AND APRIL: a tutorial on B cell survival. *Annu. Rev. Immunol.* *21*, 231–264.
- Mackay, F., Silveira, P.A., and Brink, R. (2007a). B cells and the BAFF/APRIL axis: fast-forward on autoimmunity and signaling. *Curr. Opin. Immunol.* *19*, 327–336.
- Mackay, F., Groom, J.R., and Tangye, S.G. (2007b). An important role for B-cell activation factor and B cells in the pathogenesis of Sjögren’s syndrome. *Curr. Opin. Rheumatol.* *19*, 406–413.
- MacLennan, I.C. (1994). Germinal centers. *Annu. Rev. Immunol.* *12*, 117–139.
- Maki, K., Nagata, K., Kitamura, F., Takemori, T., and Karasuyama, H. (2000). Immunoglobulin beta signaling regulates locus accessibility for ordered immunoglobulin gene rearrangements. *J. Exp. Med.* *191*, 1333–1340.
- Malbec, O., and Daëron, M. (2007). The mast cell IgG receptors and their roles in tissue inflammation. *Immunol. Rev.* *217*, 206–221.
- Manetta, J., Bina, H., Ryan, P., Fox, N., Witcher, D.R., and Kikly, K. (2014). Generation and characterization of tabalumab , a human monoclonal antibody that neutralizes both soluble and membrane-bound B-cell activating factor. 121–131.
- Mantchev, G.T., Cortesão, C.S., Rebrovich, M., Cascalho, M., and Bram, R.J. (2007). TACI is required for efficient plasma cell differentiation in response to T-independent type 2 antigens. *J. Immunol.* *179*, 2282–2288.
- Mao, C., Jiang, L., Melo-Jorge, M., Puthenveetil, M., Zhang, X., Carroll, M.C., and Imanishi-Kari, T. (2004). T Cell-Independent Somatic Hypermutation in Murine B Cells with an Immature Phenotype. *Immunity* *20*, 133–144.
- Mariette, X., Roux, S., Zhang, J., Bengoufa, D., Lavie, F., Zhou, T., and Kimberly, R. (2003). The level of BLyS (BAFF) correlates with the titre of autoantibodies in human Sjögren’s syndrome. *Ann. Rheum. Dis.* *62*, 168–171.
- Marsh, E.W., Dalke, D.P., and Pierce, S.K. (1992). Biochemical evidence for the rapid assembly and disassembly of processed antigen-major histocompatibility complex class II complexes in acidic vesicles of B cells. *J. Exp. Med.* *175*, 425–436.
- Marshall, J.S. (2004). Mast-cell responses to pathogens. *Nat. Rev. Immunol.* *4*, 787–799.
- Marsters, S. a, Yan, M., Pitti, R.M., Haas, P.E., Dixit, V.M., and Ashkenazi, a (2000). Interaction of the TNF homologues BLyS and APRIL with the TNF receptor homologues BCMA and TACI. *Curr. Biol.* *10*, 785–788.
- Matsushita, T., Horikawa, M., Iwata, Y., and Tedder, T.F. (2010). Regulatory B cells (B10 cells) and regulatory T cells have independent roles in controlling experimental autoimmune encephalomyelitis initiation and late-phase immunopathogenesis. *J. Immunol.* *185*, 2240–2252.

- Maurer, M., Theoharides, T., Granstein, R.D., Bischoff, S.C., Bienenstock, J., Henz, B., Kovanen, P., Piliponsky, A.M., Kambe, N., Vliagoftis, H., et al. (2003). What is the physiological function of mast cells? *Exp. Dermatol.* *12*, 886–910.
- Maurer, M., Wedemeyer, J., Metz, M., Piliponsky, A.M., Weller, K., Chatterjea, D., Clouthier, D.E., Yanagisawa, M.M., Tsai, M., and Galli, S.J. (2004). Mast cells promote homeostasis by limiting endothelin-1-induced toxicity. *Nature* *432*, 512–516.
- Mauri, C. (2010). Regulation of immunity and autoimmunity by B cells. *Curr. Opin. Immunol.* *22*, 761–767.
- Mazzoni, A., Siraganian, R.P., Leifer, C.A., and Segal, D.M. (2006). Dendritic cell modulation by mast cells controls the Th1/Th2 balance in responding T cells. *J. Immunol.* *177*, 3577–3581.
- McIntyre, T.M., Klinman, D.R., Rothman, P., Lugo, M., Dasch, J.R., Mond, J.J., and Snapper, C.M. (1993). Transforming growth factor beta 1 selectivity stimulates immunoglobulin G2b secretion by lipopolysaccharide-activated murine B cells. *J. Exp. Med.* *177*, 1031–1037.
- Medina, D.J., Goodell, L., Glod, J., Gélinas, C., Rabson, A.B., and Strair, R.K. (2012). Mesenchymal stromal cells protect mantle cell lymphoma cells from spontaneous and drug-induced apoptosis through secretion of B-cell activating factor and activation of the canonical and non-canonical nuclear factor  $\kappa$ B pathways. *Haematologica* *97*, 1255–1263.
- Merluzzi, S., Frossi, B., Gri, G., Parusso, S., Tripodo, C., and Pucillo, C. (2010). Mast cells enhance proliferation of B lymphocytes and drive their differentiation toward IgA-secreting plasma cells. *Blood* *115*, 2810–2817.
- Merluzzi, S., Betto, E., Ceccaroni, A.A., Magris, R., Giunta, M., and Mion, F. (2014). Mast cells, basophils and B cell connection network. *Mol. Immunol.*
- Metcalfe, D.D., Baram, D., and Mekori, Y.A. (1997). Mast cells. *Physiol. Rev.* *77*, 1033–1079.
- Metz, M., and Maurer, M. (2007). Mast cells--key effector cells in immune responses. *Trends Immunol.* *28*, 234–241.
- Metz, M., Siebenhaar, F., and Maurer, M. (2008). Mast cell functions in the innate skin immune system. *Immunobiology* *213*, 251–260.
- Mion, F., Incà, F.D., Danelli, L., Guarnotta, C., Frossi, B., Rigoni, A., Gerdes, N., Lutgens, E., Tripodo, C., Colombo, M.P., et al. (2014a). Mast Cells Control the Expansion and Differentiation of IL-10 – Competent B Cells.
- Mion, F., Tonon, S., Toffoletto, B., Cesselli, D., Pucillo, C.E., and Vitale, G. (2014b). IL-10 production by B cells is differentially regulated by immune-mediated and infectious stimuli and requires p38 activation. *Mol. Immunol.*
- Mizoguchi, A., and Bhan, A.K. (2006). A case for regulatory B cells. *J. Immunol.* *176*, 705–710.
- Moisini, I., and Davidson, A. (2009). BAFF: A local and systemic target in autoimmune diseases. *Clin. Exp. Immunol.* *158*, 155–163.
- Molderings, G.J., and Genetics, H. (2010). Mast cell function in physiology and pathophysiology. 1–12.

- Mond, J.J., Scher, I., Mosier, D.E., Baese, M., and Paul, W.E. (1978). T-independent responses in B cell-defective CBA/N mice to *Brucella abortus* and to trinitrophenyl (TNP) conjugates of *Brucella abortus*. *Eur. J. Immunol.* 8, 459–463.
- Mond, J.J., Lees, A., and Snapper, C.M. (1995). T cell-independent antigens type 2. *Annu. Rev. Immunol.* 13, 655–692.
- Moon, T.C., St Laurent, C.D., Morris, K.E., Marcet, C., Yoshimura, T., Sekar, Y., and Befus, A.D. (2010). Advances in mast cell biology: new understanding of heterogeneity and function. *Mucosal Immunol.* 3, 111–128.
- Moore, P. a. (1999). BLyS: Member of the Tumor Necrosis Factor Family and B Lymphocyte Stimulator. *Science* (80-. ). 285, 260–263.
- Moreaux, J., Legouffe, E., Jourdan, E., Quittet, P., Rème, T., Lugagne, C., Moine, P., Rossi, J.F., Klein, B., and Tarte, K. (2003). BAFF and APRIL protect myeloma cells from apoptosis induced by IL-6 deprivation and dexamethasone. *Blood*.
- Moreaux, J., Legouffe, E., Jourdan, E., Quittet, P., Rème, T., Lugagne, C., Moine, P., Rossi, J.F., Klein, B., and Tarte, K. (2004). BAFF and APRIL protect myeloma cells from apoptosis induced by interleukin 6 deprivation and dexamethasone. *Blood* 103, 3148–3157.
- Morgan, G.J., and Kaiser, M.F. (2012). How to use new biology to guide therapy in multiple myeloma. *Hematology Am. Soc. Hematol. Educ. Program* 2012, 342–349.
- Muramatsu, M., Sankaranand, V.S., Anant, S., Sugai, M., Kinoshita, K., Davidson, N.O., and Honjo, T. (1999). Specific expression of activation-induced cytidine deaminase (AID), a novel member of the RNA-editing deaminase family in germinal center B cells. *J. Biol. Chem.* 274, 18470–18476.
- Murphy, K.M., Travers, P., and Walport, M. (2009). *Janeway Immunologie*.
- Nagaoka, H., Tran, T.H., Kobayashi, M., Aida, M., and Honjo, T. (2010). Preventing AID, a physiological mutator, from deleterious activation: Regulation of the genomic instability that is associated with antibody diversity. *Int. Immunol.* 22, 227–235.
- Nakae, S., Suto, H., Iikura, M., Kakurai, M., Sedgwick, J.D., Tsai, M., and Galli, S.J. (2006). Mast cells enhance T cell activation: importance of mast cell costimulatory molecules and secreted TNF. *J. Immunol.* 176, 2238–2248.
- Nakayama, K. (1997). Furin: a mammalian subtilisin/Kex2p-like endoprotease involved in processing of a wide variety of precursor proteins. *Biochem. J.* 327 ( Pt 3, 625–635.
- Nardelli, B. (2001). Synthesis and release of B-lymphocyte stimulator from myeloid cells. *Blood* 97, 198–204.
- Nardelli, B., Belvedere, O., Roschke, V., Moore, P.A., Olsen, H.S., Migone, T.S., Sosnovtseva, S., Carrell, J.A., Feng, P., Giri, J.G., et al. (2001a). Synthesis and release of B-lymphocyte stimulator from myeloid cells. *Blood* 97, 198–204.
- Nardelli, B., Belvedere, O., Roschke, V., Moore, P. a, Olsen, H.S., Migone, T.S., Sosnovtseva, S., Carrell, J. a, Feng, P., Giri, J.G., et al. (2001b). Synthesis and release of B-lymphocyte stimulator from myeloid cells. *Blood* 97, 198–204.

- Ng, L.G., Sutherland, A.P.R., Newton, R., Qian, F., Cachero, T.G., Scott, M.L., Thompson, J.S., Wheway, J., Chtanova, T., Groom, J., et al. (2004). B cell-activating factor belonging to the TNF family (BAFF)-R is the principal BAFF receptor facilitating BAFF costimulation of circulating T and B cells. *J. Immunol.* *173*, 807–817.
- Ng, L.G., Mackay, C.R., and Mackay, F. (2005). The BAFF/APRIL system: Life beyond B lymphocytes. In *Molecular Immunology*, pp. 763–772.
- Nico, B., Mangieri, D., Crivellato, E., Vacca, A., and Ribatti, D. (2008). Mast cells contribute to vasculogenic mimicry in multiple myeloma. *Stem Cells Dev.* *17*, 19–22.
- Di Noia, J.M., and Neuberger, M.S. (2007). Molecular mechanisms of antibody somatic hypermutation. *Annu. Rev. Biochem.* *76*, 1–22.
- Novak, A.J., Bram, R.J., Kay, N.E., and Jelinek, D.F. (2002). Aberrant expression of B-lymphocyte stimulator by B chronic lymphocytic leukemia cells: A mechanism for survival. *Blood* *100*, 2973–2979.
- Novak, A.J., Darce, J.R., Arendt, B.K., Harder, B., Henderson, K., Kindsvogel, W., Gross, J.A., Greipp, P.R., and Jelinek, D.F. (2004). Expression of BCMA, TACI, and BAFF-R in multiple myeloma: A mechanism for growth and survival. *Blood* *103*, 689–694.
- Oettinger, M.A., Schatz, D.G., Gorka, C., and Baltimore, D. (1990). RAG-1 and RAG-2, adjacent genes that synergistically activate V(D)J recombination. *Science* *248*, 1517–1523.
- Ohata, J., Zvaifler, N.J., Nishio, M., Boyle, D.L., Kalled, S.L., Carson, D.A., and Kipps, T.J. (2005). Fibroblast-like synoviocytes of mesenchymal origin express functional B cell-activating factor of the TNF family in response to proinflammatory cytokines. *J. Immunol.* *174*, 864–870.
- Okazaki, I., Hiai, H., Kakazu, N., Yamada, S., Muramatsu, M., Kinoshita, K., and Honjo, T. (2003). Constitutive expression of AID leads to tumorigenesis. *J. Exp. Med.* *197*, 1173–1181.
- Orinska, Z., Bulanova, E., Budagian, V., Metz, M., Maurer, M., and Bulfone-Paus, S. (2005). TLR3-induced activation of mast cells modulates CD8+ T-cell recruitment. *Blood* *106*, 978–987.
- Ott, V.L., Cambier, J.C., Kappler, J., Marrack, P., and Swanson, B.J. (2003). Mast cell-dependent migration of effector CD8+ T cells through production of leukotriene B4. *Nat. Immunol.* *4*, 974–981.
- Paíno, T., Sarasquete, M.E., Paiva, B., Krzeminski, P., San-Segundo, L., Corchete, L.A., Redondo, A., Garayoa, M., García-Sanz, R., Gutiérrez, N.C., et al. (2014). Phenotypic, genomic and functional characterization reveals no differences between CD138<sup>++</sup> and CD138<sup>low</sup> subpopulations in multiple myeloma cell lines. *PLoS One* *9*.
- Park, S.-R. (2012). Activation-induced Cytidine Deaminase in B Cell Immunity and Cancers. *Immune Netw.* *12*, 230–239.
- Parkin, J., and Cohen, B. (2001). An overview of the immune system. *Lancet* *357*, 1777–1789.
- Pawankar, R., Okuda, M., Yssel, H., Okumura, K., and Ra, C. (1997). Nasal mast cells in perennial allergic rhinitis exhibit increased expression of the Fc $\epsilon$ RI, CD40L, IL-4, and IL-13, and can induce IgE synthesis in B cells. *J. Clin. Invest.* *99*, 1492–1499.
- Peled, J.U., Kuang, F.L., Iglesias-Ussel, M.D., Roa, S., Kalis, S.L., Goodman, M.F., and Scharff, M.D. (2008). The biochemistry of somatic hypermutation. *Annu. Rev. Immunol.* *26*, 481–511.



- Pelekanou, V., Kampa, M., Kafousi, M., Darivianaki, K., Sanidas, E., Tsiftsis, D.D., Stathopoulos, E.N., Tsapis, A., and Castanas, E. (2008). Expression of TNF-superfamily members BAFF and APRIL in breast cancer: immunohistochemical study in 52 invasive ductal breast carcinomas. *BMC Cancer* 8, 76.
- Piconese, S., Gri, G., Tripodo, C., Musio, S., Gorzanelli, A., Frossi, B., Pedotti, R., Pucillo, C.E., and Colombo, M.P. (2009). Mast cells counteract regulatory T-cell suppression through interleukin-6 and OX40/OX40L axis toward Th17-cell differentiation. *Blood* 114, 2639–2648.
- Pieper, K., Grimbacher, B., and Eibel, H. (2013). B-cell biology and development. *J. Allergy Clin. Immunol.* 131, 959–971.
- Pillai, S., Cariappa, A., and Moran, S.T. (2005). Marginal zone B cells. *Annu. Rev. Immunol.* 23, 161–196.
- Plas, D.R., Rathmell, J.C., and Thompson, C.B. (2002). Homeostatic control of lymphocyte survival: potential origins and implications. *Nat. Immunol.* 3, 515–521.
- Puga, I., Cols, M., Barra, C.M., He, B., Cassis, L., Gentile, M., Comerma, L., Chorny, A., Shan, M., Xu, W., et al. (2012). B cell-helper neutrophils stimulate the diversification and production of immunoglobulin in the marginal zone of the spleen. *Nat. Immunol.* 13, 170–180.
- Quartier, P., Bustamante, J., Sanal, O., Plebani, A., Debré, M., Deville, A., Litzman, J., Levy, J., Femand, J.P., Lane, P., et al. (2004). Clinical, immunologic and genetic analysis of 29 patients with autosomal recessive hyper-IgM syndrome due to Activation-Induced Cytidine Deaminase deficiency. *Clin. Immunol.* 110, 22–29.
- Ramanujam, M., Wang, X., Huang, W., Schiffer, L., Grimaldi, C., Akkerman, A., Diamond, B., Madaio, M.P., and Davidson, A. (2004). Mechanism of action of transmembrane activator and calcium modulator ligand interactor-Ig in murine systemic lupus erythematosus. *J. Immunol.* 173, 3524–3534.
- Ramanujam, M., Wang, X., Huang, W., Liu, Z., Schiffer, L., Tao, H., Frank, D., Rice, J., Diamond, B., Yu, K.O.A., et al. (2006). Similarities and differences between selective and nonselective BAFF blockade in murine SLE. *J. Clin. Invest.* 116, 724–734.
- Ramos, B.F., Zhang, Y., Qureshi, R., and Jakschik, B.A. (1991). Mast cells are critical for the production of leukotrienes responsible for neutrophil recruitment in immune complex-induced peritonitis in mice. *J. Immunol.* 147, 1636–1641.
- Rao, K.N., and Brown, M.A. (2008). Mast cells: Multifaceted immune cells with diverse roles in health and disease. *Ann. N. Y. Acad. Sci.* 1143, 83–104.
- Ria, R., Reale, A., De Luisi, A., Ferrucci, A., Moschetta, M., and Vacca, A. (2011). Bone marrow angiogenesis and progression in multiple myeloma. *Am. J. Blood Res.* 1, 76–89.
- Ribatti, D., Vacca, A., Nico, B., Quondamatteo, F., Ria, R., Minischetti, M., Marzullo, A., Herken, R., Roncali, L., and Dammacco, F. (1999). Bone marrow angiogenesis and mast cell density increase simultaneously with progression of human multiple myeloma. *Br J Cancer* 79, 451–455.
- Ribatti, D., Vacca, A., Marzullo, A., Nico, B., Ria, R., Roncali, L., and Dammacco, F. (2000). Angiogenesis and mast cell density with tryptase activity increase simultaneously with pathological progression in B-cell non-Hodgkin's lymphomas. *Int. J. Cancer* 85, 171–175.

- Ribatti, D., Ennas, M.G., Vacca, A., Ferreli, F., Nico, B., Orru, S., and Sirigu, P. (2003). Tumor vascularity and tryptase-positive mast cells correlate with a poor prognosis in melanoma. *Eur. J. Clin. Invest.* *33*, 420–425.
- Ribatti, D., Crivellato, E., Roccaro, A.M., Ria, R., and Vacca, A. (2004). Mast cell contribution to angiogenesis related to tumour progression. *Clin. Exp. Allergy* *34*, 1660–1664.
- Richter, C., Messerschmidt, S., Holeiter, G., Tepperink, J., Osswald, S., Zappe, A., Branschadel, M., Boschert, V., Mann, D.A., Scheurich, P., et al. (2012). The Tumor Necrosis Factor Receptor Stalk Regions Define Responsiveness to Soluble versus Membrane-Bound Ligand. *Mol. Cell. Biol.* *32*, 2515–2529.
- Rivera, J., and Gilfillan, A.M. (2006). Molecular regulation of mast cell activation. *J. Allergy Clin. Immunol.* *117*, 1214–1225; quiz 1226.
- Rivera, J., and Olivera, A. (2008). A current understanding of Fc epsilon RI-dependent mast cell activation. *Curr. Allergy Asthma Rep.* *8*, 14–20.
- Rojas, I.G., Spencer, M.L., Martínez, A., Maurelia, M.A., and Rudolph, M.I. (2005). Characterization of mast cell subpopulations in lip cancer. *J. Oral Pathol. Med.* *34*, 268–273.
- Rolink, A.G., Tschopp, J., Schneider, P., and Melchers, F. (2002). BAFF is a survival and maturation factor for mouse B cells. *Eur. J. Immunol.* *32*, 2004–2010.
- Roschke, V., Sosnovtseva, S., Ward, C.D., Hong, J.S., Smith, R., Albert, V., Stohl, W., Baker, K.P., Ullrich, S., Nardelli, B., et al. (2002). BLyS and APRIL form biologically active heterotrimers that are expressed in patients with systemic immune-based rheumatic diseases. *J. Immunol.* *169*, 4314–4321.
- Ryzhov, S., Goldstein, A.E., Matafonov, A., Zeng, D., Biaggioni, I., and Feoktistov, I. (2004). Adenosine-activated mast cells induce IgE synthesis by B lymphocytes: an A2B-mediated process involving Th2 cytokines IL-4 and IL-13 with implications for asthma. *J. Immunol.* *172*, 7726–7733.
- Sandig, H., and Bulfone-Paus, S. (2012). TLR signaling in mast cells: Common and unique features. *Front. Immunol.* *3*.
- Sauer, K., and Cooke, M.P. (2010). Regulation of immune cell development through soluble inositol-1,3,4,5-tetrakisphosphate. *Nat. Rev. Immunol.* *10*, 257–271.
- Scapini, P., Nardelli, B., Nadali, G., Calzetti, F., Pizzolo, G., Montecucco, C., and Cassatella, M. a. (2003). G-CSF-stimulated Neutrophils Are a Prominent Source of Functional BLyS. *J. Exp. Med.* *197*, 297–302.
- Scapini, P., Bazzoni, F., and Cassatella, M. a (2008a). Regulation of B-cell-activating factor (BAFF)/B lymphocyte stimulator (BLyS) expression in human neutrophils. *Immunol. Lett.* *116*, 1–6.
- Scapini, P., Bazzoni, F., and Cassatella, M.A. (2008b). Regulation of B-cell-activating factor (BAFF)/B lymphocyte stimulator (BLyS) expression in human neutrophils. *Immunol. Lett.* *116*, 1–6.
- Schatz, D.G., Oettinger, M.A., and Baltimore, D. (1989). The V(D)J recombination activating gene, RAG-1. *Cell* *59*, 1035–1048.
- Schneider, P., and Huard, B. (2010). Buffy's, B cells, and membrane BAFF. *Arthritis Rheum.* *60*, 2–4.

- Schneider, P., MacKay, F., Steiner, V., Hofmann, K., Bodmer, J.L., Holler, N., Ambrose, C., Lawton, P., Bixler, S., Acha-Orbea, H., et al. (1999). BAFF, a novel ligand of the tumor necrosis factor family, stimulates B cell growth. *J. Exp. Med.* *189*, 1747–1756.
- Shivakumar, L., and Ansell, S. (2006). Targeting B-lymphocyte stimulator/B-cell activating factor and a proliferation-inducing ligand in hematologic malignancies. *Clin. Lymphoma Myeloma* *7*, 106–108.
- Skokos, D., Le Panse, S., Villa, I., Rousselle, J.C., Peronet, R., David, B., Namane, A., and Mécheri, S. (2001). Mast cell-dependent B and T lymphocyte activation is mediated by the secretion of immunologically active exosomes. *J. Immunol.* *166*, 868–876.
- Specchia, M.L., de Waure, C., Gualano, M.R., Doria, A., Turchetti, G., Pippo, L., Di Nardo, F., Capizzi, S., Cadeddu, C., Kheiraoui, F., et al. (2014). Health technology assessment of belimumab: a new monoclonal antibody for the treatment of systemic lupus erythematosus. *Biomed Res. Int.* *2014*, 704207.
- St John, A.L., Rathore, A.P.S., Yap, H., Ng, M.-L., Metcalfe, D.D., Vasudevan, S.G., and Abraham, S.N. (2011). Immune surveillance by mast cells during dengue infection promotes natural killer (NK) and NKT-cell recruitment and viral clearance. *Proc. Natl. Acad. Sci. U. S. A.* *108*, 9190–9195.
- Stavnezer, J., Guikema, J.E.J., and Schrader, C.E. (2008). Mechanism and regulation of class switch recombination. *Annu. Rev. Immunol.* *26*, 261–292.
- Stone, K.D., Prussin, C., and Metcalfe, D.D. (2010). IgE, mast cells, basophils, and eosinophils. *J. Allergy Clin. Immunol.* *125*.
- Sun, J., Lin, Z., Feng, J., Li, Y., and Shen, B. (2008). BAFF-targeting therapy, a promising strategy for treating autoimmune diseases. *Eur. J. Pharmacol.* *597*, 1–5.
- Supajatura, V., Ushio, H., Nakao, A., Akira, S., Okumura, K., Ra, C., and Ogawa, H. (2002). Differential responses of mast cell Toll-like receptors 2 and 4 in allergy and innate immunity. *J. Clin. Invest.* *109*, 1351–1359.
- Tai, Y.T., Li, X.F., Breitkreutz, I., Song, W., Neri, P., Catley, L., Podar, K., Hideshima, T., Chauhan, D., Raje, N., et al. (2006). Role of B-cell-activating factor in adhesion and growth of human multiple myeloma cells in the bone marrow microenvironment. *Cancer Res* *66*, 6675–6682.
- Tangye, S.G., Bryant, V.L., Cuss, A.K., and Good, K.L. (2006). BAFF, APRIL and human B cell disorders. *Semin. Immunol.* *18*, 305–317.
- Tataroğlu, C., Kargi, A., Özkal, S., Eşrefoğlu, N., and Akkoçlu, A. (2004). Association of macrophages, mast cells and eosinophil leukocytes with angiogenesis and tumor stage in non-small cell lung carcinomas (NSCLC). *Lung Cancer* *43*, 47–54.
- Thomas, M.D., Srivastava, B., and Allman, D. (2006). Regulation of peripheral B cell maturation. *Cell. Immunol.* *239*, 92–102.
- Thompson, J.S., Schneider, P., Kalled, S.L., Wang, L., Lefevre, E.A., Cachero, T.G., MacKay, F., Bixler, S.A., Zafari, M., Liu, Z.Y., et al. (2000). BAFF binds to the tumor necrosis factor receptor-like molecule B cell maturation antigen and is important for maintaining the peripheral B cell population. *J. Exp. Med.* *192*, 129–135.

- Thompson, J.S., Bixler, S. a, Qian, F., Vora, K., Scott, M.L., Cachero, T.G., Hession, C., Schneider, P., Sizing, I.D., Mullen, C., et al. (2001). BAFF-R, a newly identified TNF receptor that specifically interacts with BAFF. *Science* 293, 2108–2111.
- Tkaczyk, C., Frandji, P., Botros, H.G., Poncet, P., Lapeyre, J., Peronet, R., David, B., and Mecheri, S. (1996). Mouse bone marrow-derived mast cells and mast cell lines constitutively produce B cell growth and differentiation activities. *J Immunol* 157, 1720–1728.
- Tsubata, T., and Reth, M. (1990). The products of pre-B cell-specific genes (15 and VpreB) and the immunoglobulin m chain form a complex that is transported onto the cell surface. *J. Exp. Med.* 172, 973–976.
- Vacca, A., Ribatti, D., Roncali, L., Ranieri, G., Serio, G., Silvestris, F., and Dammacco, F. (1994). Bone marrow angiogenesis and progression in multiple myeloma. *Br. J. Haematol.* 87, 503–508.
- Varadaradjalou, S., Feger, F., Thieblemont, N., Hamouda, N.B., Pleau, J.M., Dy, M., and Arock, M. (2003). Toll-like receptor 2 (TLR2) and TLR4 differentially activate human mast cells. *Eur.J.Immunol.* 33, 899–906.
- Vassalli, P. (1992). The pathophysiology of tumor necrosis factors. *Annu. Rev. Immunol.* 10, 411–452.
- Vincent, F.B., Saulep-Easton, D., Figgett, W. a, Fairfax, K. a, and Mackay, F. (2013). The BAFF/APRIL system: emerging functions beyond B cell biology and autoimmunity. *Cytokine Growth Factor Rev.* 24, 203–215.
- Vincent, F.B., Morand, E.F., Schneider, P., and Mackay, F. (2014). The BAFF/APRIL system in SLE pathogenesis. *Nat. Rev. Rheumatol.* 10, 365–373.
- Vitale, G., Mion, F., and Pucillo, C. (2010). Regulatory B cells: evidence, developmental origin and population diversity. *Mol. Immunol.* 48, 1–8.
- Wallweber, H.J.A., Compaan, D.M., Starovasnik, M.A., and Hymowitz, S.G. (2004). The crystal structure of A proliferation-inducing ligand, APRIL. *J. Mol. Biol.* 343, 283–290.
- Wang, L.D., and Clark, M.R. (2003). B-cell antigen-receptor signalling in lymphocyte development. *Immunology* 110, 411–420.
- Wang, H., Marsters, S.A., Baker, T., Chan, B., Lee, W.P., Fu, L., Tumas, D., Yan, M., Dixit, V.M., Ashkenazi, A., et al. (2001). TACI-ligand interactions are required for T cell activation and collagen-induced arthritis in mice. *Nat. Immunol.* 2, 632–637.
- Weiss, B.M., Abadie, J., Verma, P., Howard, R.S., and Kuehl, W.M. (2009). A monoclonal gammopathy precedes multiple myeloma in most patients. *Blood* 113, 5418–5422.
- Weller, C.L., Collington, S.J., Brown, J.K., Miller, H.R.P., Al-Kashi, A., Clark, P., Jose, P.J., Hartnell, A., and Williams, T.J. (2005). Leukotriene B4, an activation product of mast cells, is a chemoattractant for their progenitors. *J. Exp. Med.* 201, 1961–1971.
- Xu, S., and Lam, K.P. (2001). B-cell maturation protein, which binds the tumor necrosis factor family members BAFF and APRIL, is dispensable for humoral immune responses. *Mol. Cell. Biol.* 21, 4067–4074.

- Xu, Z., Zan, H., Pone, E.J., Mai, T., and Casali, P. (2012). Immunoglobulin class-switch DNA recombination: induction, targeting and beyond. *Nat. Rev. Immunol.* *12*, 517–531.
- Yang, M., Sun, L., Wang, S., Ko, K.-H., Xu, H., Zheng, B.-J., Cao, X., and Lu, L. (2010a). Novel function of B cell-activating factor in the induction of IL-10-producing regulatory B cells. *J. Immunol.* *184*, 3321–3325.
- Yang, Z., Zhang, B., Li, D., Lv, M., Huang, C., Shen, G.X., and Huang, B. (2010b). Mast cells mobilize myeloid-derived suppressor cells and Treg cells in tumor microenvironment via IL-17 pathway in murine hepatocarcinoma model. *PLoS One* *5*.
- Yu, W., Nagaoka, H., Jankovic, M., Misulovin, Z., Suh, H., Rolink, A., Melchers, F., Meffre, E., and Nussenzweig, M.C. (1999). Continued RAG expression in late stages of B cell development and no apparent re-induction after immunization. *Nature* *400*, 682–687.
- Zhang, M., Ko, K.H., Lam, Q.L.K., Lo, C.K.C., Srivastava, G., Zheng, B., Lau, Y.L., and Lu, L. (2005a). Expression and function of TNF family member B cell-activating factor in the development of autoimmune arthritis. *Int. Immunol.* *17*, 1081–1092.
- Zhang, X., Park, C.S., Yoon, S.O., Li, L., Hsu, Y.M., Ambrose, C., and Choi, Y.S. (2005b). BAFF supports human B cell differentiation in the lymphoid follicles through distinct receptors. *Int. Immunol.* *17*, 779–788.
- Zheng, Y., Gallucci, S., Gaughan, J.P., Gross, J.A., and Monestier, M. (2005). A role for B cell-activating factor of the TNF family in chemically induced autoimmunity. *J. Immunol.* *175*, 6163–6168.